

Disc Capacitors

Product catalog

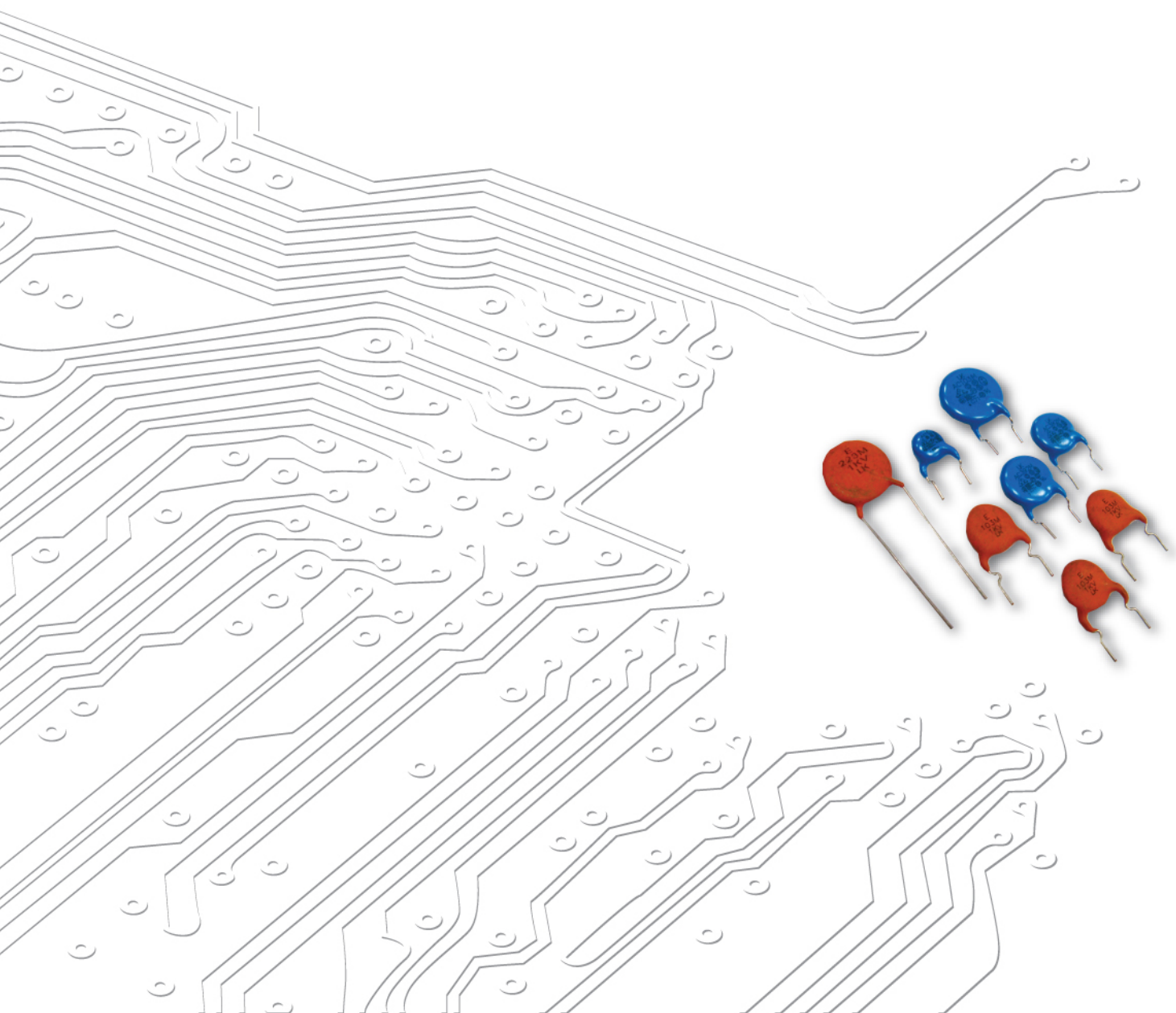

Product Portfolio

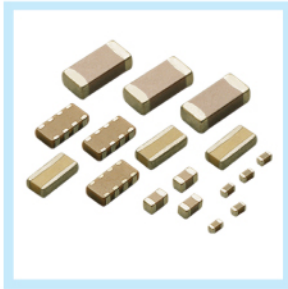

Multilayer Ceramic Capacitors (MLCC)

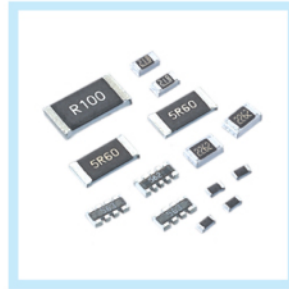

Chip-Resistor



Disc Capacitors



RF Device and High Frequency Inductors



Inductors

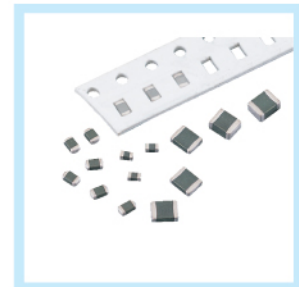

Varistors and SMD-Varistors

IEC-63 Nominal Resistance / Capacitance

E1	100																							
E3	100								220								470							
E6	100		150		220		330		470		680													
E12	100	120	150	180	220	270	330	390	470	560	680	820												
E24	100	110	120	130	150	160	180	200	220	240	270	300	330	360	390	430	470	510	560	620	680	750	820	910
E96	100	102	121	124	147	150	178	182	215	221	261	267	316	324	383	392	464	475	562	576	681	698	825	845
	105	107	127	130	154	158	187	191	226	232	274	280	332	340	402	412	487	499	590	604	715	732	866	887
	110	113	133	137	162	165	196	200	237	243	287	294	348	357	422	432	511	523	619	634	750	768	909	931
	115	118	140	143	169	174	205	210	249	255	301	309	365	374	442	453	536	549	649	665	787	806	953	976

E6: $\sqrt[6]{10} \approx 1.46$ E12: $\sqrt[12]{10} \approx 1.21$

E1 series resistance: 1Ω, 10Ω, 100Ω, 1000Ω, 10000Ω, 100000Ω

INDEX

Subject	Page
CERAMIC CAPACITOR PART NUMBER EXPLANATION	1
CLASS I 50V,100V,500V,1KV,2KV,3KV,6KV TEMPERATURE COMPENSATION TYPE	2- 6
CLASS II 50V,100V,500V,1KV,2KV,3KV HI-K TYPE	7- 11
CLASS III SEMI-CONDUCTIVE TYPE	12
1KV,2KV,3KV LOW DISSPATION LB,LR TYPE	13- 19
SAFETY STANDARD CERAMIC CAPACITOR PART NUMBER EXPLANATION	20
AH TYPE-CLASS X1/Y1, AC TYPE-CLASSX1/Y2	21- 22
SAFETY STANDARD CERAMIC CAPACITOR DETAIL SPECIFICATION	23- 24
APPROVAL FILE NUMBER, TAPING SPECIFICATION AND DIMENSION, MARKING	25- 29
RADIAL LEADED MULTILAYER CERAMIC CAPACITOR PART NUMBER EXPLANATION	30
RADIAL LEADED CAPACITOR FEATURES DIMENSION AND CAPACITANCE RANGE	31- 32
MPQ(Min. Packing Quantity)	33

*The specifications are subject to change or products in it may be discontinued without advance notice. Please check with our sales representatives or product engineers before ordering.

*This catalog has only typical specifications because there is no space for detailed specifications. Therefore, please approve our product specifications or transact the approval sheet for product specifications before ordering.



CERAMIC DISC CAPACITOR SAP Part Number Explanation

■ To order, please also specify Pan Overseas Part No. as the following example for SAP system :

YP	500	102	K	040	B	20	C	7	H
Dielectric Code	Voltage Code	Capacitance Code	Tolerance Code	Diameter Code	Lead Style	Length or Packing	Length Tolerance	Pitch	Coating
①	②	③	④	⑤	⑥	⑦	⑧	⑨	⑩

① Dielectric Code

CLASS I:		
CODE	T.C.(ppm/°C)	
CH	CH (0±60)	
SL	SL (+350~-1000)	
CLASS II:		
CODE	T.C.(ΔC%)	
YP	Y5P(±10%)	
ZU	Z5U(+22 ~ -56%)	
ZV	Z5V(+22 ~ -82%)	
YU	Y5U(+22 ~ -56%)	
YV	Y5V(+22 ~ -82%)	
CLASS III:		
CODE	T.C.(ΔC%)	
FY	Y5V(+22 ~ -82%)	
Low DF:		
CODE	D.F.	T.C.(ΔC%)
LR	≤0.2%	Y5R ±15%(-25°C to +85°C) +15/-30% (85°Cto+125°C)
LB	≤0.5%	Y5P(±10%)

② Voltage Code

CODE	WV
160	16 VDC
250	25 VDC
500	50 VDC
501	500VDC
102	1K VDC
202	2K VDC
302	3K VDC
602	6KVDC

⑤ Diameter Code

CODE	Diameter max
040	Refer to the product diameter D max
050	
060	
070	
080	
090	
100	
110	
120	
130	
140	

③ Capacitance Code

CODE	Capacitance
0R5	0.5 pF
010	1 pF
100	10 pF
472	4700 pF
103	0.01uF
104	0.1uF

④ Tolerance Code

CODE	Tolerance
C	± 0.25pF
D	± 0.5pF
J	± 5%
K	± 10%
M	± 20%
Z	-20 ~ +80 %

⑥ Lead Style - Reference Lead Style

⑦ Packing / Pitch Lead Length

Taping(ex)	
CODE	Packing & Pitch
AF	Ammo Box & Pitch 15.0 mm
AN	Ammo Box & Pitch 12.7 mm
AM	Ammo Box & Pitch 25.4 mm
Bulk (ex)	
CODE	Length
3E	3.5mm
04	4.0mm
4E	4.5mm
05	5.0mm
20	20.0mm

⑧ Length Tolerance

CODE	Length Tolerance
A	± 0.5 mm(Only for short kink lead type)
B	± 1.0 mm
C	Min.
D	Tapping & Special Purpose

⑨ Pitch

CODE	Length Pitch
2	2.5±0.8mm
5	5.0±0.8mm (for Bulk)
5	5.0±0.8-0.2mm (for Taping)
7	7.5 ± 1mm
0	10.0 ± 1mm

⑩ Coating Type

CODE	Coating
A	Phenolic resin-Halogen free and Pb free, W.V.≤1KV
H	Epoxy resin-Halogen free and Pb free, W.V.≥2KV

Features:

- Capacitance has linear temperature coefficient
- Capacitance high stability
- Epoxy Coating for 2KV, 3KV,6KV parts (equivalent to UL94V-0 standards)
- RoHS Compliance
- Halogen free products are available
- Low loss at wide range of frequency

General specification:

Capacitance Range	1pF to 820pF (See page 3 to page 6)
Capacitance Tolerance	±0.25pF(for 2~5pF), ±0.5pF(for 6~10pF), ±5%(for 12~820pF),
Operating Temperature Range	-25°C ~ +125°C.
Rated Voltage	50,100, 500,1000,2000,3000,6000 VDC
Q Factor @ 1MHz, 1±0.2 Vrms, 25°C	C≥30 pF.....Q≥1,000, C < 30 pF.....Q≥400+20°C
Insulation Resistance (IR) @ 25°C	10,000 MΩ Minimum
Dielectric Strength	50~500VDC:3 times the rated WVDC ; 1K,2K,3KVDC:2 times the rated WVDC; 6KVDC:1.5 times the rated WVDC.
Testing Parameters	1MHz ±20%, 1.0Vrms±0.2Vrms

Lead style:

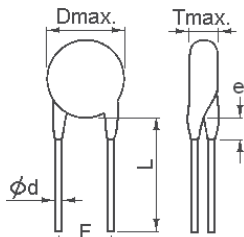
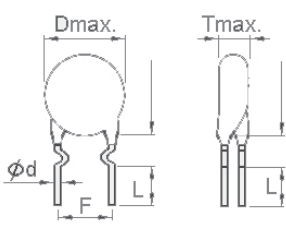
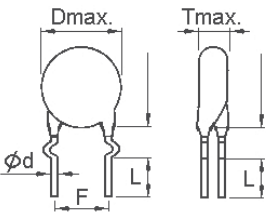
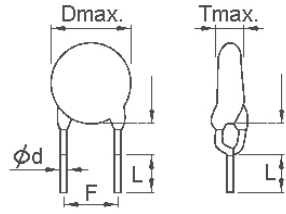
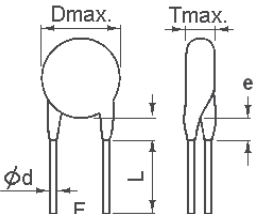
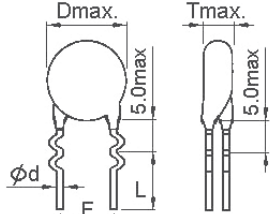
Lead type	Lead Code	Lead configuration	Lead type	Lead Code	Lead configuration
Type 1 Straight long lead	B	lead style:B 	Type 4 Inside kink lead	H	lead style:H 
Type 2 Outside kink lead	X	lead style:X 	Type 5 Vertical kink short lead	D	lead style:D 
Type 3 Straight short lead	L	lead style:L 	Type 6 Double outside kink lead	M	lead style:M 

Manufacturing product range Cap. Value v.s. Rate voltage, Product diameter & Type

Photo:

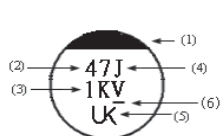

T.C	CH (CLASS I, Temperature:-25°C~+85°C, T.C.C.: 0±60ppm/°C)																
Rate voltage	50V(CH500) & 100V(CH101)								500V(CH501)				1KV(CH102)			2KV(CH202)	
Dφ(Code)	040	050	060	070	080	100	110	120	050	060	070	080	050	060	070	060	080
D max. (mm)	4.5	5.5	6.5	7.5	8.5	10.5	11.5	12.5	5.5	6.5	7.5	8.5	6.0	7.0	8.0	7.5	9.5
T max. (mm)	3.5	3.5	3.5	3.5	3.5	3.5	3.5	3.5	4.0	4.0	4.0	4.0	4.5	4.5	4.5	4.5	4.5
1	010								010								
2	020								020								
3	030								030								
4	040								040							040	
5	050								050							050	
6	060								060							060	
7	070								070							070	
8	080								080				080			080	
10	100								100				100			100	
12	120								120				120			120	
15	150								150				150			150	
18	180								180				180			180	
20	200								200				200			200	
22	220								220				220			220	
24	240								240					240			240
27	270								270					270			270
33	330								330					330			330
36		360								360					360		360
39		390								390					390		390
47		470								470					470		470
51		510								510					510		
56		560								560					560		
62			620								620				620		
68			680								680				680		
75			750								750				750		
82				820							820				820		
100				101							101				101		
120					121							121					
150					151							151					
180						181											
200						201											
220						221											
240						241											
270						271											
300							301										
330							331										
360								361									
390								391									
φd (mm)	0.55±0.05																
Packing	TAPING or BULK						BULK		TAPING or BULK				TAPING or BULK			TAPING or BULK	
Coating	Phenolic Resin															Epoxy Resin	

Marking	1. Temperature characteristic	2. Nominal capacitance	3. Rated voltage		4. Capacitance tolerance	5. manufacturer's identification	6. Halogen and Pb free
	Phenolic resin: No marking but recognized by black color presented on the top of product. Epoxy resin: Shall be marked "CH"	Identified by 3-figure code. Ex. 5pF → "5" 100 pF → "101"	50V/100V	Marked as underline	C: ±0.25pF D: ±0.5pF J: ±5%	Shall be marked as "UK", but when Dφ ≤ 060 shall be omitted.	There is a "_" marking under the code "V" as the coating is Halogen and Pb free Epoxy.
			500V	No marking (is blank)			
			1000V	Marked "1kV"			
			2000V	Marked "2kV"			

CERAMIC DISC CAPACITOR

Class I 50V,100V,500V,1KV,2KV,3KV,6KV, Temperature Compensation Type



Manufacturing product range Cap. Value v.s. Rate voltage, Product diameter & Type

Photo:



T.C	SL (CLASS I, Temperature:+20°C~+85°C, T.C.C.: +350 ~ -1000ppm/°C)																				
Rate voltage	50V(SL500);100V(SL101)					500V(SL501)					1KV(SL102)				2KV(SL202)						
Dφ(Code)	040	050	060	070	080	090	100	050	060	070	080	100	050	060	070	080	060	070	080	100	120
D max. (mm)	4.5	5.5	6.5	7.5	8.5	9.5	10.5	5.5	6.5	7.5	9.0	10.5	6.0	7.0	8.0	9.0	7.5	8.5	9.5	11.5	13.5
T max. (mm)	3.5	3.5	3.5	3.5	3.5	3.5	3.5	4.0	4.0	4.0	4.0	4.0	4.5	4.5	4.5	4.5	4.5	4.5	4.5	4.5	4.5
8	080							080													
10	100							100					100								
12	120							120					120								
15	150							150					150					150			
18	180							180					180					180			
20	200							200					200					200			
22	220							220					220					220			
24	240							240					240					240			
27	270							270					270					270			
30	300							300					300					300			
33	330							330					330					330			
36	360							360					360					360			
39	390							390					390					390			
47	470							470					470					470			
51	510							510					510					510			
56	560							560					560					560			
68	680							680					680					680			
75	750							750						750				750			
82	820							820						820				820			
100	101							101						101				101			
120		121							121					121					121		
150		151							151						151				151		
180		181								181					181					181	
200			201							201						201				201	
220			221							221						221				221	
240			241								241									241	
270				271							271									271	
300				301							301										301
330				331							331										331
360				361								361									
390				391								391									
470					471																
500						501															
510						511															
560						561															
680							681														
750							751														
820							821														
φd (mm)	0.55±0.05																				
Packing	TAPING or BULK					TAPING or BULK					TAPING or BULK				TAPING or BULK					BULK	
Coating	Phenolic Resin										Epoxy Resin										

Marking	1. Temperature characteristic	2. Nominal capacitance	3. Rated voltage		4. Capacitance tolerance	5. manufacturer's identification	6. Halogen and Pb free
	SL:No marking.	Identified by 3-figure code. Ex. 5pF→"5" 100 pF→"101"	50V/100V	Marked as underline	C:±0.25pF D:±0.5pF J:±5%	Shall be marked as " UK" , but when Dφ≤060 shall be omitted.	There is a " _ " marking under the code "V" as the coating is Halogen and Pb free Epoxy.
			500V	No marking (is blank)			
			1000V	Marked "1kV"			
			2000V	Marked "2kV"			

**Manufacturing product range
Cap. Value v.s. Rate voltage, Product diameter & Type**

Photo:

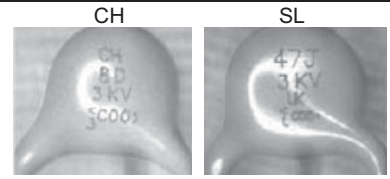

T.C	CH (Temperature:-25°C~+85°C, T.C.C.: 0±60ppm/°C)				SL (Temperature:+20°C~+85°C, T.C.C.: +350 ~ -1000ppm/°C)		
Rate voltage	3KV(CH302)				3KV(SL302)		
Dφ(Code)	060	070	080	090	060	070	080
D max. (mm)	7.5	8.5	9.5	10.5	7.5	8.5	9.5
T max. (mm)	5.0	5.0	5.0	5.0	5.0	5.0	5.0
2	020						
3	030						
4	040						
5	050				050		
6	060				060		
7	070				070		
8	080				080		
10	100				100		
12	120				120		
15	150				150		
18	180				180		
20	200				200		
22	220				220		
24		240			240		
27			270		270		
30			300		300		
33				330	330		
36					360		
39					390		
47						470	
51						510	
56						560	
62						620	
68						680	
75							750
82							820
100							101
φd (mm)	0.55±0.05						
Packing	TAPING or BULK						
Coating	Epoxy Resin						

	1. Temperature characteristic	2. Nominal capacitance	3. Capacitance tolerance	4. Rated voltage	5. Manufacturer's identification	6. Halogen and Pb free
	CH: Be marked "CH" SL:No marking	1. Cap.≥100pF Ex. 120pF →"121" 2. Cap<100pF, Ex. 22pF→"22"	C: ±0.25pF D: ±0.5pF J: ±5%	3000V : Be marked "3kv"	Shall be marked as "UK ", but when Dφ≤060 shall be omitted.	When the epoxy resin is Halogn and Pb free, there is a "-"marking.
	Definition of date code marking:					
	7. Supplier of Epoxy □: K-company , : P-company	8.No. of test equipment 1~9: No.1~No.9, J: No.10, K: No.11, L: No.12	9.Factory of manufacture C: GZ Plant D: DL Plant	10.Year of manufacture 1:2011, 2:2012, 3:2013,	11.Month of manufacture 1~9:January~ September, O: October, N: November, D: December	12.Week of manufacture by month week 1: - week 2: • week 3: : week 4: ' week 5: ;

Remark: K40-- K100-- K130-- K300--

CERAMIC DISC CAPACITOR

Class I 50V,100V,500V,1KV,2KV,3KV,6KV, Temperature Compensation Type



Manufacturing product range Cap. Value v.s. Rate voltage, product diameter & type					Photo: CH		SL	
T.C.	CH (Temperature:-25°C~+85°C, T.C.C.: 0±60ppm/°C)				SL (Temperature:+20°C~+85°C, T.C.C.: +350 ~ -1000ppm/°C)			
Rate voltage	6KV				6KV			
D φ (Code)	060	080	090	110	060	080	090	
D max. (mm)	7.5	9.5	10.5	12.5	7.5	9.5	10.5	
T max. (mm)	5.0	5.0	5.0	5.0	5.0	5.0	5.0	
2	020				020			
3	030				030			
5	050				050			
6	060				060			
7	070				070			
8	080				080			
10	100				100			
12	120				120			
15	150				150			
18	180				180			
20		200			200			
22		220			220			
27		270			270			
30			300		300			
33			330		330			
39			390		390			
47				470		470		
51						510		
56						560		
68							680	
82							820	
100							101	
φd (mm)	0.55±0.05							
Packing	TAPING or BULK							
Coating	Epoxy Resin							



	1. Temperature characteristic	2. Nominal capacitance	3. Capacitance tolerance	4. Rated voltage	5. Manufacturer's identification	6. Halogen and Pb free
	CH: Be marked "CH" SL: No marking	1. Cap.≥100pF Ex. 120pF →"121" 2. Cap<100pF, Ex. 22pF→"22"	C: ±0.25pF D: ±0.5pF J: ±5%	6000V : Be marked "6kV"	Shall be marked as "UK ", but when Dφ≤060 shall be omitted.	When the epoxy resin is Halogn and Pb free, there is a "-"marking.
	Definition of date code marking:					
7. Supplier of Epoxy	8. No. of test equipment	9. Factory of manufacture	10. Year of manufacture	11. Month of manufacture	12. Week of manufacture by month	
ك: K-company , : P-company	1~9: No.1~No.9, J: No.10, K: No.11, L: No.12	C: GZ Plant D: DL Plant	1:2011, 2:2012, 3:2013,	1~9: January~ September, O: October, N: November, D: December	week 1: - week 2: • week 3: : week 4: ' week 5: ;	

Remark: K40-- K100-- K130-- K300--

Features:

- Capacitance has non-linear temperature coefficient
- Large capacitance in small size
- Epoxy Coating for 2KV and 3KV parts (equivalent to UL94V-0 standards)
- RoHS Compliance
- Halogen free products are available
- Wide range of general purposes applications

General specification:

Capacitance Range	100pF to 22000pF (See page 8 to page 11)
Capacitance Tolerance	±10%(for Y5P), ±20%(for Z5U), +80% -20%(for Z5U&Z5V&Y5V)
Operating Temperature Range	-25°C ~ +85°C (Y5P, Y5V) ; 10°C ~ +85°C (Z5U, Z5V)
Rated Voltage	50,100, 500,1000,2000,3000VDC
Dissipation Factor (tan δ)	Y5P, Z5U : tanδ≤2.5%, Z5V, Y5V : tanδ≤5.0%
Insulation Resistance (IR) @ 25°C	10,000 MΩMinimum or 200 MΩμF whichever is smaller
Dielectric Strength	50~500VDC: 2.5 times the rated WVDC; 1K,2K,3KVDC: 2 times the rated WVDC
Testing Parameters	1KHz ±20%, 1.0Vrms±0.2Vrms

Lead style:

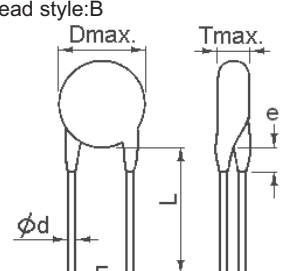
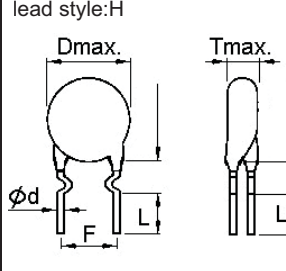
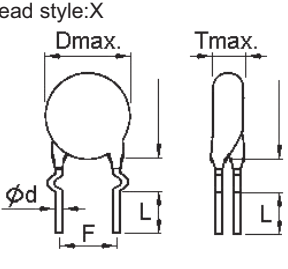
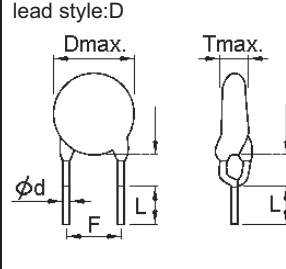
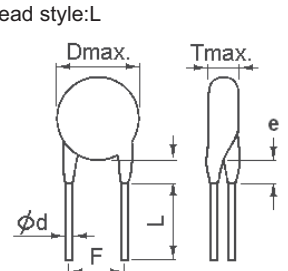
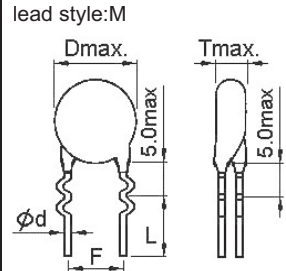
Lead type	Lead Code	Lead configuration	Lead type	Lead Code	Lead configuration
Type 1 Straight long lead	B	lead style:B 	Type 4 Inside kink lead	H	lead style:H 
Type 2 Outside kink lead	X	lead style:X 	Type 5 Vertical kink short lead	D	lead style:D 
Type 3 Straight short lead	L	lead style:L 	Type 6 Double outside kink lead	M	lead style:M 

CERAMIC DISC CAPACITOR

Class II 50V,100V,500V,1KV,2KV,3KV, Hi-K Type

Manufacturing product range Cap. Value v.s. Rate voltage, product diameter & type	Photo: 
--	--

T.C.	Y5P (CLASS II, Temperature:-25°C~+85°C, T.C.C.:±10%)																															
Rate voltage	50V(YP500) & 100V(YP101)								500V(YP501)								1KV(YP102)						2KV(YP202)									
Dφ(Code)	040	050	060	070	080	090	100	040	050	060	070	080	090	100	110	130	050	060	070	080	100	120	060	080	090	100	130	140				
D max. (mm)	4.5	5.5	6.5	7.5	8.5	9.5	11.0	4.5	5.5	6.5	7.5	9.0	10.0	11.0	12.0	14.0	6.0	7.0	8.0	9.0	11.0	13.0	7.5	9.5	10.5	11.5	14.5	15.5				
T max. (mm)	3.5	3.5	3.5	3.5	3.5	3.5	3.5	4.0	4.0	4.0	4.0	4.0	4.0	4.0	4.0	4.0	4.5	4.5	4.5	4.5	4.5	4.5	4.5	4.5	4.5	4.5	4.5	4.5				
100	101							101									101								101							
120	121							121									121								121							
150	151							151									151								151							
180	181							181									181								181							
200	201							201									201								201							
220	221							221									221								221							
240	241							241									241								241							
270	271							271									271								271							
330	331							331									331								331							
390	391							391									391								391							
470	471							471									471								471							
560	561							561									561								561							
680	681							681										681							681							
820	821								821									821								821						
1000	102								102									102							102							
1200		122								122									122								122					
1500		152								152									152								152					
1800		182									182									182							182					
2000		202									202									202							202					
2200		222									222									222							222					
2700			272									272									272						272					
3000			302									302									302						302					
3300			332										332								332						332					
3900				392									392									392					392					
4700				472										472								472					472					
5000					502									502																		
5600					562									562																		
6800						682									682																	
8200							822									822																
10000								103									103															
φd (mm)	0.55±0.05																															
Packing	TAPING or BULK				BULK				TAPING or BULK				BULK				TAPING or BULK				BULK				TAPING or BULK				BULK			
Coating	Phenolic Resin														Epoxy Resin																	

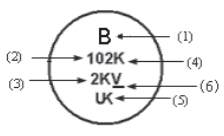
Marking	1. Temperature characteristic	2. Nominal capacitance	3. Rated voltage	4. Capacitance tolerance	5. manufacturer's identification	6. Halogen and Pb free								
	Be marked "B".	Identified by 3-figure code. Ex. 1000pF→"102" 3300pF→"332"	<table border="1" style="width: 100%; border-collapse: collapse;"> <tr><td style="width: 50%;">50V/100V</td><td style="width: 50%;">Marked as underline</td></tr> <tr><td>500V</td><td>No marking (is blank)</td></tr> <tr><td>1000V</td><td>Marked "1kV"</td></tr> <tr><td>2000V</td><td>Marked "2kV"</td></tr> </table>	50V/100V	Marked as underline	500V	No marking (is blank)	1000V	Marked "1kV"	2000V	Marked "2kV"	K:±10%	Shall be marked as "UK", but when Dφ≤060 shall be omitted.	There is a "_" marking under the code "V" as the coating is Halogen and Pb free Epoxy.
50V/100V	Marked as underline													
500V	No marking (is blank)													
1000V	Marked "1kV"													
2000V	Marked "2kV"													

Manufacturing product range Cap. Value v.s. Rate voltage, product diameter & type													Photo:					
																		
T.C.	Z5U (CLASS II, Temperature: +10°C~+85°C, T.C.C.: +22~-56%)																	
Rate voltage	50V(ZU500)&100V(ZU101)				500V(ZU501)				1KV(ZU102)				2KV(ZU202)					
Dφ(Code)	040	050	060	070	050	060	070	090	050	070	090	100	060	070	080	090	110	130
D max. (mm)	4.5	5.5	6.5	7.5	5.5	6.5	7.5	9.5	6.0	8.0	10.0	11.0	7.5	8.5	9.5	10.5	12.5	14.5
T max. (mm)	3.5	3.5	3.5	3.5	4.0	4.0	4.0	4.0	4.5	4.5	4.5	4.5	4.5	4.5	4.5	4.5	4.5	4.5
1000					102				102				102					
1200					122				122				122					
1500					152				152				152					
2200	222				222				222				222					
2700	272				272					272					272			
3300	332					332				332					332			
3600	362					362				362							362	
3900	392					392				392							392	
4700	472						472			472							472	
5000		502								502								
5600							562											562
6800							682				682							682
8200			822									822						822
10000				103				103				103						103
φd (mm)	0.55±0.05																	
Packing	TAPING or BULK																	BULK
Coating	Phenolic Resin												Epoxy Resin					

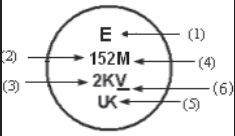
Marking	1. Temperature characteristic	2. Nominal capacitance	3. Rated voltage		4. Capacitance tolerance	5. manufacturer's identification	6. Halogen and Pb free
	Be marked "E".	Identified by 3-figure code. Ex. 1000pF→"102" 3300pF→"332"	50V/100V	Marked as underline	M:±20% Z:-20~+80%	Shall be marked as "UK", but when Dφ≤060 shall be omitted.	There is a "_" marking under the code "V" as the coating is Halogen and Pb free Epoxy.
			500V	No marking (is blank)			
			1000V	Marked "1kV"			
			2000V	Marked "2kV"			

CERAMIC DISC CAPACITOR

Class II 50V,100V,500V,1KV,2KV,3KV, Hi-K Type

Manufacturing product range Cap. Value v.s. Rate voltage, product diameter & type	Photo: 
--	--

T.C.	Z5V (CLASS II, Temperature: +10°C~+85°C, T.C.C.: +22~-82%)									
Rate voltage	50V(ZV500) & 100V(ZV101)				500V(ZV501)	1KV(ZV102)			2KV(ZV202)	
Dφ (Code)	050	060	070	080	080	060	080	100	120	
D max. (mm)	5.5	6.5	7.5	8.5	9.0	7.0	9.0	11.0	13.5	
T max. (mm)	3.5	3.5	3.5	3.5	4.0	4.5	4.5	4.5	4.5	
1000	102									
1500	152					152				
2200	222					222				
2700	272					272				
3300	332					332				
3900	392						392			
4700	472						472			
10000		103			103			103	103	
20000			203							
22000				223						
φd (mm)	0.55±0.05									
Packing	TAPING or BULK								BULK	
Coating	Phenolic Resin								Epoxy Resin	

T.C.	Y5V (CLASS II, Temperature: -25°C~+85°C, T.C.C.: +22% ~82%)												
Rate voltage	50V(YV500)				100V(YV101)			500V(YV501)			1KV(YV102)	2KV(YV202)	
Dφ(Code)	040	050	060	080	040	050	060	050	070	080	100	070	120
D max. (mm)	4.5	5.5	6.6	8.5	4.5	5.5	6.6	5.5	7.5	8.5	11.0	8.5	13.5
T max. (mm)	3.5	3.5	3.5	3.5	3.5	3.5	3.5	4.0	4.0	4.0	4.5	5.0	5.0
1000	102				102							102	
2200		222				222		222					222
4700		472				472			472				
10000			103				103			103	103		103
22000				223									
φd (mm)	0.55±0.05												
Packing	TAPING or BULK											BULK	
Coating	Phenolic Resin										Epoxy Resin		

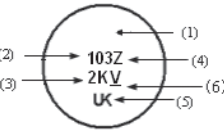
Marking	1. Temperature characteristic	2. Nominal capacitance	3. Rated voltage	4. Capacitance tolerance	5. manufacturer's identification	6. Halogen and Pb free								
	Z5V, Y5V: the logo is "F", but the "F" shall be omitted.	Identified by 3-figure code. Ex. 1000pF→"102" 3300pF→"332" 4700pF→"472"	<table border="1" style="width: 100%; border-collapse: collapse;"> <tr> <td style="width: 50%;">50V/100V</td> <td style="width: 50%;">Marked as underline</td> </tr> <tr> <td>500V</td> <td>No marking (is blank)</td> </tr> <tr> <td>1000V</td> <td>Marked "1kV"</td> </tr> <tr> <td>2000V</td> <td>Marked "2kV"</td> </tr> </table>	50V/100V	Marked as underline	500V	No marking (is blank)	1000V	Marked "1kV"	2000V	Marked "2kV"	M:±20% Z:-20~+80%	Shall be marked as "UK", but when Dφ ≤ 060 shall be omitted.	There is a "_" marking under the code "V" as the coating is Halogen and Pb free Epoxy.
50V/100V	Marked as underline													
500V	No marking (is blank)													
1000V	Marked "1kV"													
2000V	Marked "2kV"													

Manufacturing product range Cap. Value v.s. Rate voltage, product diameter & type

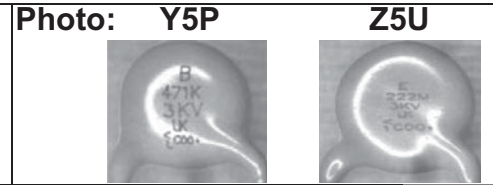

T.C.	Y5P (CLASS II, Temperature:-25°C~+85°C, T.C.C.:±10%)					Z5U (CLASS II, Temperature: +10°C~+85°C, T.C.C.: +22~56%)						
Rate voltage	3KV(YP302)					3KV(ZU302)						
Dφ (Code)	060	070	090	110	130	060	080	100	110	120	140	170
D max. (mm)	8.0	9.0	11.0	13.0	15.0	8.0	10.0	12.0	13.0	14.0	16.0	19.0
T max. (mm)	6.0	6.0	6.0	6.0	6.0	6.0	6.0	6.0	6.0	6.0	6.0	6.0
100	101											
120	121											
150	151											
180	181											
220	221											
270	271											
330	331											
390		391										
470		471										
560		561										
680			681									
820			821									
1000			102			102						
1200				122			122					
1500				152			152					
1800				182			182					
2200					222		222					
2700								272				
3300								332				
3900									392			
4700										472		
5600											562	
6800												682
φd (mm)	0.55±0.05											
Packing	TAPING or BULK											
Coating	Epoxy Resin											

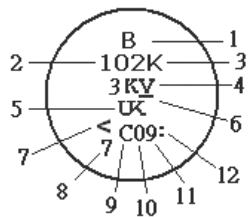

1. Temperature characteristic	2. Nominal capacitance	3. Capacitance tolerance	4. Rated voltage	5. Manufacturer's identification	6. Halogen and Pb free
Y5P:Be marked "B" Z5U:Be marked "E"	Identified by 3-figure code when Cap.≥100pF Ex. 1000pF →"102"	K:±10%(for Y5P) M:±20%(for Z5U)	3000V : Be marked "3kV"	Shall be marked as "UK", but when Dφ≤060 shall be omitted.	When the epoxy resin is Halogn and Pb free, there is a "-"marking.
Definition of date code marking:					
7.Supplier of Epoxy	8.No. of test equipment	9.Factory of manufacture	10.Year of manufacture	11.Month of manufacture	12.Week of manufacture by month
<: K-company , : P-company	1~9: No.1~No.9, J: No.10, K: No.11, L: No.12	C: GZ Plant D: DL Plant	1:2011, 2:2012, 3:2013,	1~9: January~ September, O: October, N: November, D: December	week 1: - week 2: • week 3: : week 4: ' week 5: ;

Features:

- Large capacitance in small size
- Low loss at wide range of frequency
- Cost saving by placing film capacitors
- Capacitance has linear temperature coefficient
- Stable capacitance change over specified temperature range
- RoHS Compliance
- Halogen free products are available

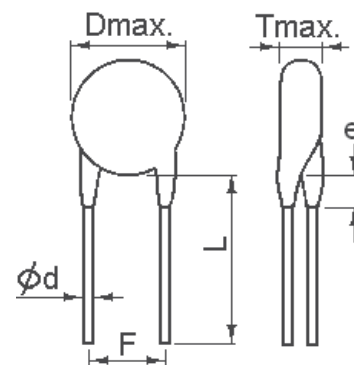

General specification:

Capacitance Range	100000pF
Capacitance Tolerance	+80%-20%
Operating Temperature Range	-25°C ~+ 85°C
Rated Voltage	16,25&50 VDC
Dissipation Factor (tan δ)	Y5V 16V.....tan δ≤7.5% Y5V 25/50V.....tan δ≤5.0%
Insulation Resistance (IR) @ 25°C	16V.....100MΩ Minimum or 10MΩμF 25/50V...1000MΩ Minimum or 20MΩμF
Dielectric Strength	2 times the rated WVDC
Testing Parameters	1KHz±20%, 0.1Vrms Maximum

Capacitance chart:

Manufacturing Product Range			
T.C.	FY (Y5V) CLASS III		
Rate voltage	16V	25V	50V
Dφ(Code)	060	060	060
D max. (mm)	7.0	7.0	7.0
T max. (mm)	3.5	3.5	3.5
0.1uF	104	104	104
φd (mm)	0.55±0.05		
Packing	TAPING or BULK		
Coating	Phenolic Resin		

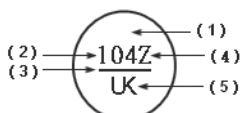
Marking	1. Temperature characteristic	2. Nominal Capacitance	3. Rated voltage		4. Capacitance tolerance	5. Manufacturer's identification
	Y5V: the product logo is "F", but it is omitted on marking.	Identified by 3-figure code. 0.1uF → "104"	16V/25V	Marked with code: 16V → "16V" 25V → "25V"	Z: -20~+80%	50V: Shall be marked as "UK", 16V&25V shall be omitted.
			50V	Marked as underline		

Features:

- Reduced heat dissipation permitted due to small dielectric loss of the ceramic material
- Operating temperature range is guaranteed up to 125 degree C
- Coated with flame-retardant epoxy resin (equivalent to UL94V-0 standards)
- RoHS Compliance
- Halogen free products are available
- Ideal for use on high frequency pulse circuits such as a horizontal resonance circuit for CTV and snubber circuits for switching power supplies

General specification:

Capacitance Range	100pF to 4700pF(See page 14 to page 15)
Capacitance Tolerance	±10%,
Operating Temperature Range	-25°C ~ +125°C
Rated Voltage	1K,2K,3K VDC
Dissipation Factor (tan δ)	LB: tan δ≤0.5% ; LR: tan δ≤0.2%
Insulation Resistance (IR) @ 25°C	10000MΩ Minimum or 200MΩμF whichever is smaller (500VDC,60sec)
Dielectric Strength	2 times the rated WVDC
Testing Parameters	1KHz ±20%, 1.0Vrms±0.2Vrms

Lead style:

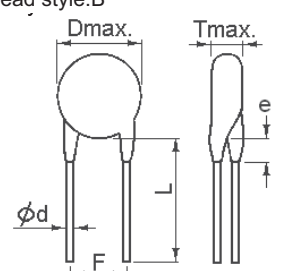
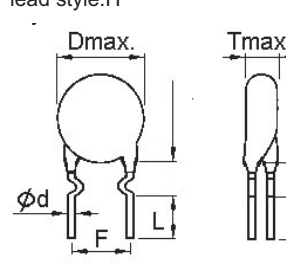
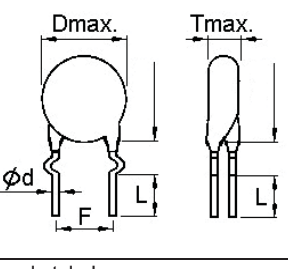
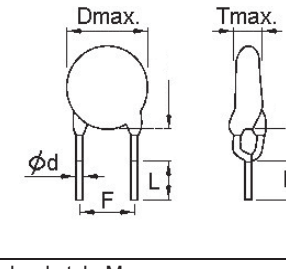
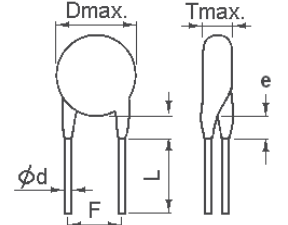
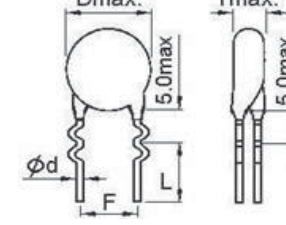
Lead type	Lead Code	Lead configuration	Lead type	Lead Code	Lead configuration
Type 1 Straight long lead	B	lead style:B 	Type 4 Inside kink lead	H	lead style:H 
Type 2 Outside kink lead	X	lead style:X 	Type 5 Vertical kink short lead	D	lead style:D 
Type 3 Straight short lead	L	lead style:L 	Type 6 Double outside kink lead	M	lead style:M 

CERAMIC DISC CAPACITOR

1KV, 2KV, 3KV Low Dissipation LB,LR Type

■ LB Series:

Part Number	Rated Voltage.	Cap. in pF	Cap. Tol. (%)	Dimensions in mm	
				D max.	T Max.
LB102101K050□□□□□	1000VDC	100	±10%	6.5	4.5
LB102151K050□□□□□	1000VDC	150	±10%	6.5	4.5
LB102181K050□□□□□	1000VDC	180	±10%	6.5	4.5
LB102221K050□□□□□	1000VDC	220	±10%	6.5	4.5
LB102271K050□□□□□	1000VDC	270	±10%	6.5	4.5
LB102331K050□□□□□	1000VDC	330	±10%	6.5	4.5
LB102391K050□□□□□	1000VDC	390	±10%	6.5	4.5
LB102471K050□□□□□	1000VDC	470	±10%	6.5	4.5
LB102561K050□□□□□	1000VDC	560	±10%	6.5	4.5
LB102681K060□□□□□	1000VDC	680	±10%	7.5	4.5
LB102821K060□□□□□	1000VDC	820	±10%	7.5	4.5
LB102102K060□□□□□	1000VDC	1000	±10%	7.5	4.5
LB102152K070□□□□□	1000VDC	1500	±10%	8.5	4.5
LB102182K070□□□□□	1000VDC	1800	±10%	8.5	4.5
LB102222K080□□□□□	1000VDC	2200	±10%	9.5	4.5
LB102332K100□□□□□	1000VDC	3300	±10%	11.5	4.5
LB102392K100□□□□□	1000VDC	3900	±10%	11.5	4.5
LB102472K120□□□□□	1000VDC	4700	±10%	13.5	4.5
LB202101K050□□□□□	2000VDC	100	±10%	6.5	5.0
LB202151K050□□□□□	2000VDC	150	±10%	6.5	5.0
LB202221K050□□□□□	2000VDC	220	±10%	6.5	5.0
LB202271K050□□□□□	2000VDC	270	±10%	6.5	5.0
LB202331K050□□□□□	2000VDC	330	±10%	6.5	5.0
LB202391K050□□□□□	2000VDC	390	±10%	6.5	5.0
LB202471K050□□□□□	2000VDC	470	±10%	6.5	5.0
LB202561K060□□□□□	2000VDC	560	±10%	7.5	5.0
LB202681K060□□□□□	2000VDC	680	±10%	8.5	5.0
LB202821K070□□□□□	2000VDC	820	±10%	8.5	5.0
LB202102K070□□□□□	2000VDC	1000	±10%	8.5	5.0
LB202122K070□□□□□	2000VDC	1200	±10%	8.5	5.0
LB202152K080□□□□□	2000VDC	1500	±10%	9.5	5.0
LB202182K090□□□□□	2000VDC	1800	±10%	10.5	5.0
LB202222K100□□□□□	2000VDC	2200	±10%	11.5	5.0
LB202272K110□□□□□	2000VDC	2700	±10%	12.5	5.0
LB202332K120□□□□□	2000VDC	3300	±10%	13.5	5.0
LB202392K130□□□□□	2000VDC	3900	±10%	14.5	5.0
LB202472K140□□□□□	2000VDC	4700	±10%	15.5	5.0
LB302101K050□□□□□	3000VDC	100	±10%	6.5	6.0
LB302151K050□□□□□	3000VDC	150	±10%	6.5	6.0
LB302221K050□□□□□	3000VDC	220	±10%	6.5	6.0
LB302331K050□□□□□	3000VDC	330	±10%	6.5	6.0
LB302391K050□□□□□	3000VDC	390	±10%	6.5	6.0
LB302471K060□□□□□	3000VDC	470	±10%	7.5	6.0
LB302561K060□□□□□	3000VDC	560	±10%	7.5	6.0
LB302681K070□□□□□	3000VDC	680	±10%	8.5	6.0
LB302821K080□□□□□	3000VDC	820	±10%	9.5	6.0
LB302102K080□□□□□	3000VDC	1000	±10%	9.5	6.0
LB302152K100□□□□□	3000VDC	1500	±10%	11.5	6.0
LB302222K120□□□□□	3000VDC	2200	±10%	13.5	6.0
LB302272K130□□□□□	3000VDC	2700	±10%	14.5	6.0
LB302332K140□□□□□	3000VDC	3300	±10%	15.5	6.0
LB302392K150□□□□□	3000VDC	3300	±10%	16.5	6.0
LB302472K160□□□□□	3000VDC	4700	±10%	17.5	6.0

LR Series:

Part Number	Rated Voltage.	Cap. in pF	Cap. Tol. (%)	Dimensions in mm	
				D max.	T Max.
LR102101K050□□□□□	1000VDC	100	±10%	6.5	4.5
LR102151K050□□□□□	1000VDC	150	±10%	6.5	4.5
LR102221K050□□□□□	1000VDC	220	±10%	6.5	4.5
LR102271K050□□□□□	1000VDC	270	±10%	6.5	4.5
LR102331K050□□□□□	1000VDC	330	±10%	6.5	4.5
LR102391K050□□□□□	1000VDC	390	±10%	6.5	4.5
LR102471K050□□□□□	1000VDC	470	±10%	6.5	4.5
LR102681K060□□□□□	1000VDC	680	±10%	7.5	4.5
LR102821K070□□□□□	1000VDC	1000	±10%	8.5	4.5
LR102102K070□□□□□	1000VDC	1000	±10%	8.5	4.5
LR102152K090□□□□□	1000VDC	1500	±10%	10.5	4.5
LR102222K100□□□□□	1000VDC	2200	±10%	11.5	4.5
LR102332K130□□□□□	1000VDC	3300	±10%	14.5	4.5
LR202101K050□□□□□	2000VDC	100	±10%	6.5	5.0
LR202151K050□□□□□	2000VDC	150	±10%	6.5	5.0
LR202221K050□□□□□	2000VDC	220	±10%	6.5	5.0
LR202271K050□□□□□	2000VDC	270	±10%	6.5	5.0
LR202331K060□□□□□	2000VDC	330	±10%	7.5	5.0
LR202391K060□□□□□	2000VDC	390	±10%	7.5	5.0
LR202471K060□□□□□	2000VDC	470	±10%	7.5	5.0
LR202561K070□□□□□	2000VDC	560	±10%	8.5	5.0
LR202681K070□□□□□	2000VDC	680	±10%	8.5	5.0
LR202821K080□□□□□	2000VDC	820	±10%	9.5	5.0
LR202102K090□□□□□	2000VDC	1000	±10%	10.5	5.0
LR202122K100□□□□□	2000VDC	1200	±10%	11.5	5.0
LR202152K110□□□□□	2000VDC	1500	±10%	12.5	5.0
LR202182K120□□□□□	2000VDC	1800	±10%	13.5	5.0
LR202222K130□□□□□	2000VDC	2200	±10%	14.5	5.0
LR202332K160□□□□□	2000VDC	3300	±10%	17.5	5.0
LR302101K050□□□□□	3000VDC	100	±10%	6.5	6.0
LR302151K050□□□□□	3000VDC	150	±10%	6.5	6.0
LR302221K050□□□□□	3000VDC	220	±10%	6.5	6.0
LR302331K060□□□□□	3000VDC	330	±10%	7.5	6.0
LR302391K070□□□□□	3000VDC	390	±10%	8.5	6.0
LR302471K080□□□□□	3000VDC	470	±10%	9.5	6.0
LR302561K080□□□□□	3000VDC	560	±10%	9.5	6.0
LR302681K090□□□□□	3000VDC	680	±10%	10.5	6.0
LR302821K100□□□□□	3000VDC	820	±10%	11.5	6.0
LR302102K100□□□□□	3000VDC	1000	±10%	11.5	6.0
LR302152K130□□□□□	3000VDC	1500	±10%	14.5	6.0
LR302222K150□□□□□	3000VDC	2200	±10%	16.5	6.0

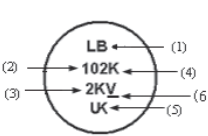
Marking	1. Temperature characteristic	2. Nominal capacitance	3. Rated voltage		4. Capacitance tolerance	5. manufacturer's identification	6. Halogen and Pb free
	LB:Be marked "LB" LR:Be marked "LR"	Identified by 3-figure code. Ex. 100pF→"101" 2200pF→"222"	1000V	Marked "1kV"	K:±10%	Shall be marked as "UK", but when Dφ ≤ 060 shall be omitted.	There is a "_" marking under the code "V" as the coating is Halogen and Pb free Epoxy.
			2000V	Marked "2kV"			
			3000V	Marked "3kV"			

LB: Cap. Change: ±10%(-25°C~+85°C), DF:0.5%Max. ;

LR: Cap. Change:-30%~+15%(-25°C~+125°C), DF:0.2%Max.

■ Caution

1. Caution (Rating)

1.1 Operating Voltage

When dc-rated capacitors are to be used in ac or ripple current circuits, be sure to maintain the V_{p-p} value of the applied voltage or the V_{o-p} which contains dc bias within the rated voltage range.

When the voltage is applied to the circuit, starting or stopping may generate irregular voltage for a transit period because of resonance or switching. Be sure to use a capacitor with a rated voltage range that includes these irregular voltages.

When using the low-dissipation (LB, LR Char.) series in a high-frequency and high-voltage circuit, be sure to read the instructions in item 4.

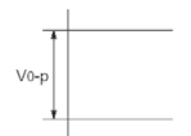
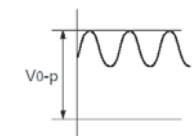
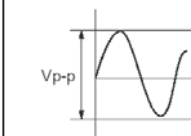
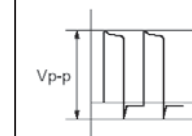
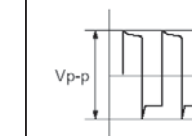
Voltage	DC Voltage	DC+AC Voltage	AC Voltage	Pulse Voltage(1)	Pulse Voltage(2)
Positional measurement					

1.2 Operating Temperature And Self-Generated Heat

Keep the surface temperature of a capacitor below the upper limit of its rated operating temperature range, and be sure to take into account the heat generated by the capacitor itself. When the capacitor is used in a high-frequency current, pulse current or similar current, it may self-generate heat due to dielectric loss. The applied voltage load (*) should be such that the capacitor's self-generated heat is within 15°C at an atmosphere temperature of 25°C. When measuring, use a thermocouple of small thermal capacity-k of $\varnothing 0.1\text{mm}$ in conditions where the capacitor is not affected by radiant heat from other components or surrounding ambient fluctuations.

Excessive heat may lead to deterioration of the capacitor's characteristics and reliability. (Never attempt to perform measurement with the cooling fan running. otherwise, accurate measurement cannot be ensured.)

1.3 Fail-Safe

When capacitor is broken, failure may result in a short circuit. Be sure to provide an appropriate fail-safe function like a fuse on your product if failure would follow an electric shock, fire or fume.

1.4 Load Reduction and Self-generated Heat During

Application of High-frequency and High-voltage

Due to the low self-heating characteristics of low dissipation capacitors, the allowable electric power of these capacitors is generally much higher than that of B characteristic capacitors. However, in case the self heating temperature is 15°C under a high-frequency voltage whose peak-to-peak value equals the capacitor's rated voltage, the capacitor's power consumption may exceed it's allowable electric power.

Therefore, when using the Low D.F. series in a high-frequency and high-voltage circuit with a frequency of 1kHz or higher, make sure that the V_{p-p} values including the DC bias, do not exceed the applied voltage value specified in Table 1. Also make sure that the self-heating temperature (the difference between the capacitor's surface temperature and the capacitor's ambient temperature) at an ambient temperature of 25°C does not exceed the value specified in Table 1.

As shown in Fig. 2, the self-heating temperature depends on the ambient temperature. Therefore, if you are not able to set the ambient temperature to approximately 25°C, please contact our sales representatives or product engineers.

[Table 1] Allowable conditions at high frequency

Series	DC rated voltage	Allowable conditions at High-frequency *3		Capacitor's ambient temp. *2
		Applied voltage (Max.)	Self-heating temp. (25°C ambient temp.)*1	
LB、LR	1KV	600Vp-p	15°C Max.	-25 ~ +125°C
		1000Vp-p	5°C Max.	
	2KV	1000Vp-p	10°C Max.	
		2000Vp-p	5°C Max.	
	3KV	3000Vp-p	5°C Max.	

*1 Fig. 1 shows the relationship between the applied voltage and the allowable self-heating temperature regarding 1 to 3KV rated voltage of the low D.F. series LB,LR characteristic.

*2 Fig. 2 When the ambient temperature is 85 to 125°C, the applied voltage needs to be further reduced. If the low D.F. series needs to be used at an ambient temperature of 85 to 125°C, please contact our sales representatives or product engineers.

*3 Fig. 3 shows reference data on the allowable voltage-frequency characteristic for a sine wave voltage.

Failure to follow the above cautions (items 1.1 to 1.4) may result, worst case, in a short circuit and cause fuming or partial dispersion when the product is used.

Fig 1 : Relationship Between Applied Voltage and Self-heating Temperature (Allowable Self-heating Temp. at 25°C Ambient Temp.)

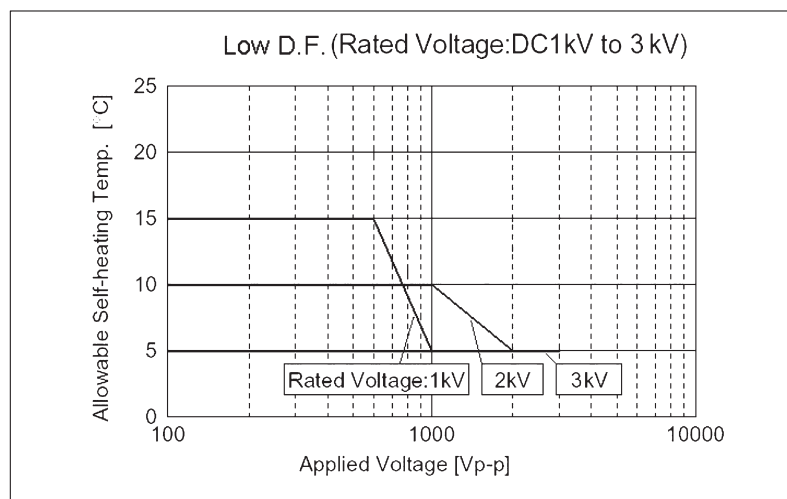

Fig 2 : Dependence of Self-heating Temperature on Ambient Temperature.

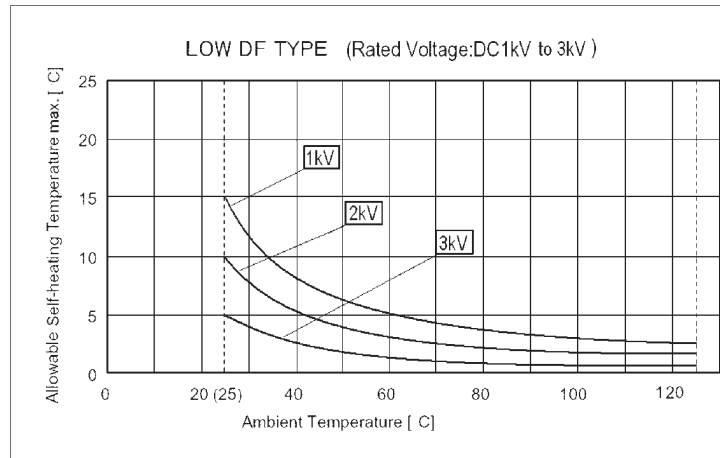
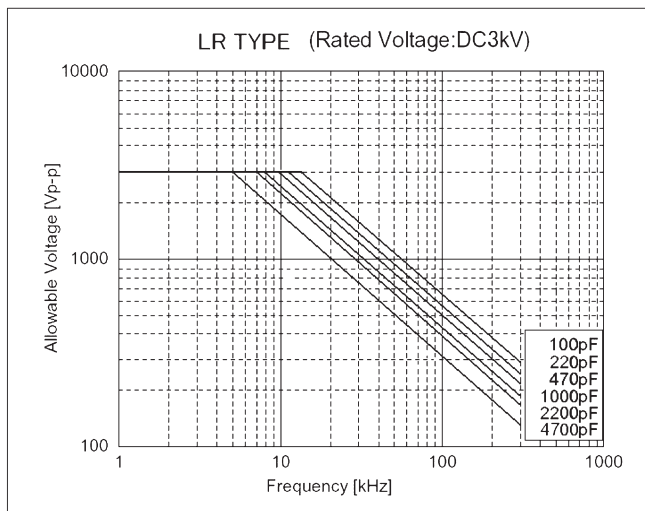
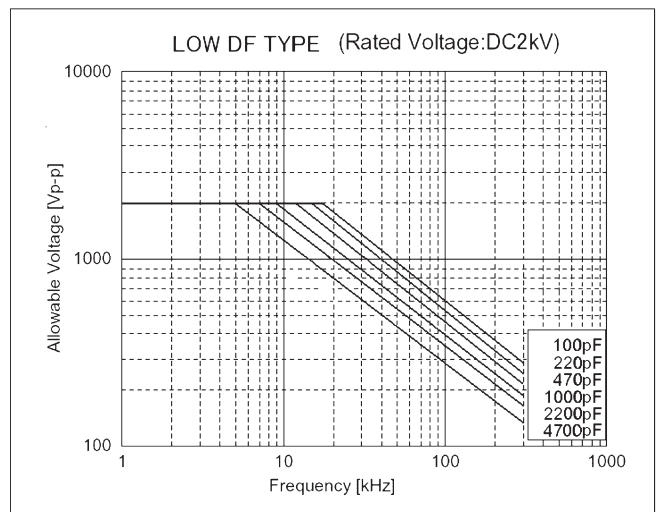
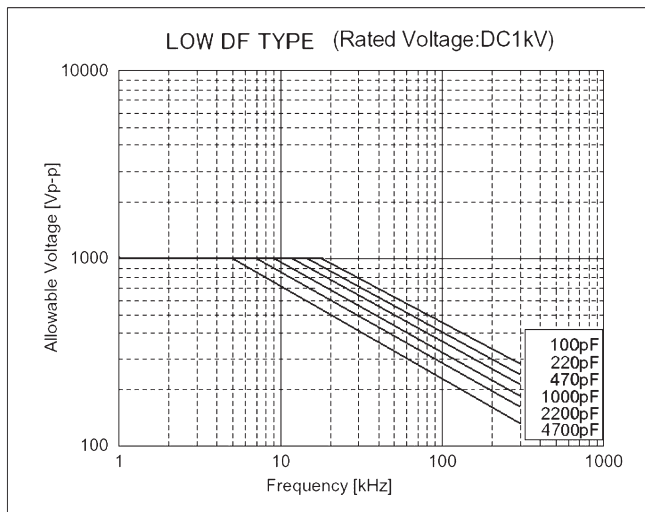

Fig 3 : Allowable Voltage (Sine Wave Voltage) – Frequency Characteristics (At Ambient Temperature of 85°C or less)





CERAMIC DISC CAPACITOR

1KV, 2KV, 3KV Low Dissipation LB,LR Type

Because of influence of harmonics, when the applied voltage is a rectangular wave or pulse wave voltage (instead of a sine wave voltage), the heat generated by the capacitor is higher than the value obtained by application of the sine wave with the same fundamental frequency. Roughly calculated for reference, the allowable voltage for a rectangular wave or pulse wave corresponds approximately to the allowable voltage for a sine wave whose fundamental frequency is twice as large as that of the rectangular wave or pulse wave. This allowable voltage, however, varies depending on the voltage and current waveforms.

Therefore, you are requested to make sure that the self-heating temperature is not higher than the value specified in Table 1.

2. Caution (Storage And Operating Condition)

I. Operating And Storage Environment

The insulating coating of capacitors does not form a perfect seal; therefore, do not use or store capacitors in a corrosive atmosphere, especially where chloride gas, sulfide gas, acid, alkali, salt or the like are present. And avoid exposure to Moisture. Before cleaning, bonding or molding this product, verify that these processes do not affect product quality by testing the performance of a cleaned, bonded or molded product in the intended equipment. Store the capacitors where the temperature and relative humidity do not exceed -10 to 40 degrees centigrade and 15 to 85 %.

Use capacitors within 6 months.

Failure to follow the above cautions may result, worst case, in a short circuit and cause fuming or partial dispersion when the product is used.

3. Caution (Soldering And Mounting)

I. Vibration And Impact

Do not expose a capacitor or its leads to excessive shock or vibration during use.

II. Soldering

When soldering this product to a Pcb / Pwb, do not exceed the solder heat resistance specification of the capacitor. Subjecting this product to excessive heating could melt the internal junction solder and may result in thermal shocks that can crack the ceramic element. When soldering capacitor with a soldering iron, it should be performed in following conditions.

Temperature of iron-tip: 400 °C Max.

Soldering iron wattage: 50W Max.

Soldering time: 3.5 sec. Max.

Failure to follow the above cautions may result, worst case, in a short circuit and cause fuming or partial dispersion when the product is used.

4. Caution (Handling)

Vibration And Impact

Do not expose a capacitor or its leads to excessive shock or vibration during use.

Failure to follow the above cautions may result, worst case, in a short circuit and cause fuming or partial dispersion when the product is used.

■ Notice

1. Notice (Soldering And Mounting)

Cleaning (ultrasonic cleaning)

To perform ultrasonic cleaning, observe the following conditions.

Rinse bath capacity: output of 20-watts per liter or less.

Rinsing time: 5 min. Maximum.

Do not vibrate the Pcb/Pwb directly.

Excessive ultrasonic cleaning may lead to fatigue destruction of the lead wires.

2. Notice (Rating)

Low D.F. series

Capacitance might change greatly depending on the surrounding temperature or an applied voltage.

So, it is not likely to be suitable for use in a time constant circuit. Please contact us if you need detailed information.

SAFETY STANDARD CERAMIC CAPACITOR SAP Part Number Explanation

To order, please also specify Pan Overseas Part No. as the following example for SAP system :

YV	0AC	472	M	10	0	L	20	C	7	H
①	②	③	④	⑤	⑥	⑦	⑧	⑨	⑩	⑪

① Temperature characteristic (identified code):

CODE	CH(NPO)	SL	YP (Y5P)	YU (Y5U)	YV (Y5V)
Cap. Change (%)	0±60ppm/°C	-1000~+350ppm/°C (+20°C~+85°C)	±10%	+20%to -55%	+30%to -80%

② TYPE (identified by 3-figure code) :

0AC=AC(X1-400V~/Y2-250V~) ; 1AC=AC(X1-440V~/Y2-300V~)(only approval for VDE//ENEC/UL/CSA)

0AH=AH(X1-400V~/Y1-250V~) ; 1AH=AH(X1-400V~/Y1-400V~)

0AS=AS(X1-760V~/Y1-500V~) (Only approval for VDE//ENEC/UL/CUL)

③ Capacitance (identified by 3-figure code)

④ Capacitance tolerance (identified by code)

⑤ Nominal body diameter dimension (identified by 2-figure code)

⑥ Internal control code:0—Normal, other code—Special control

⑦ Lead Style:

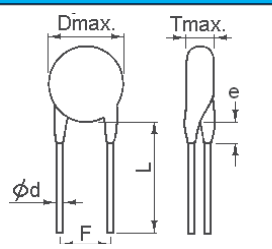
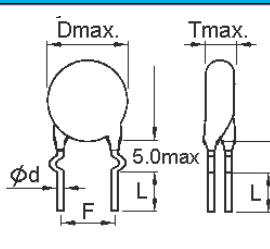
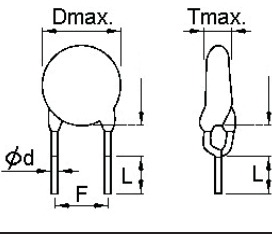
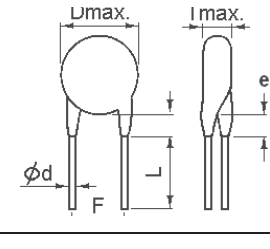
Lead type & Code	Lead configuration	Lead type & Code	Lead configuration
Type B Straight long lead	lead style:B 	Type X Outside kink lead	lead style:X 
Type D Vertical kink short lead	lead style:D 	Type L Straight short lead	lead style:L 

⑧ Packing mode and lead length (identified by 2-figure code)

Taping Code	Description	Bulk Code	Description
AM	Box and Pitch:25.4 mm (10.0mm)	3E	lead length L : 3.5mm
AF	Box and Pitch:15.0 mm (Pitch=7.5mm)	04	lead length L : 4.0mm
		4E	lead length L : 4.5mm
		20	lead length L : 20mm

⑨ Length tolerance

Code	Description
A	±0.5 mm (only for kink lead type)
B	±1.0 mm
C	MIN.
D	Taping special purpose

⑩ Pitch

Code	Description
7	7.5±1 mm
0	10±1 mm

⑪ Epoxy resin code

Code	Description
H	Halogen and Pb free, epoxy resin (Ag electrode)
T	Halogen and Pb free, epoxy resin (Cu electrode)

Introduction :

Ideal for use as X/Y capacitors for AC line filters and primary-secondary coupling on switching power supplies and AC adapters applications.

Having internationally recognized safety certifications, these capacitors are well-suited for applications that require keeping potentially disruptive or damaging line transients and EMI out of susceptible equipment. They are also an ideal solution in situations where there is a need to suppress line disturbances at the power.

Features :

- Compact size
- Cost effective products
- Ideal for across the line applications
- Safety Standard Recognized for AC applications
- Coated with flame-retardant epoxy resin (equivalent to UL94V-0 standards)
- RoHS Compliance
- Halogen free products are available

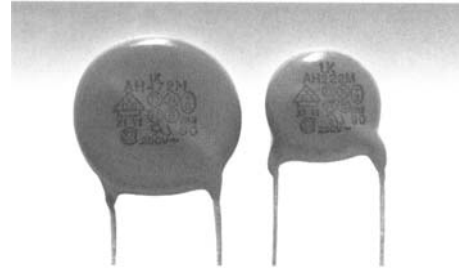

Approval standards :

Agencies	UL	CSA	CQC	KTL	VDE, ENEC, SEMKO, NEMKO, DEMKO, FIMKO, SEV, KEMA
Standard No.	UL60384-14: 2009	E60384-14: 09	GB/T 14472-1998	K60384-14	IEC384-14 3rd Edition
Rated Voltage	0AC = AC(X1-400V~/Y2-250V~) 1AC = AC(X1-440V~/Y2-300V~)(only approval for VDE/ENEC/UL/CSA) 0AH = AH(X1-400V~/Y1-250V~) 1AH = AH(X1-400V~/Y1-400V~) 0AS=AS(X1-760V~/Y1-500V~)				
Capacitance Value(pF)	AH: 2 ~ 4700 AC: 2 ~10000 AS: 100~4700				

General specification :

Capacitance Range	AH:2pF to 4700pF; AC:2pF to 10000pF; AS: 100pF to 4700pF
Capacitance Tolerance	±0.25pF, ±0. 5pF, ±5%, ±10%, ±20%
Operating Temperature Range	-40°C ~ +125°C
Temperature Coefficient (ΔC Max)	±60ppm/°C (CH), -1000~+350ppm/°C (SL), ±10% (Y5P), +30~80% (Y5V), +20~55% (Y5U)
Voltage Resistance	AH Type: X1:400Vac / Y1:400Vac or 250Vac ; AC Type: X1:400Vac or 440Vac / Y2:250VAC or 300Vac AS Type: X1:760Vac / Y1:500Vac
Dissipation Factor(tanδ) or Q	CH&SL: 30pF&above:Q≥1000 Below 30pF:Q≥400+20×C @20°C, 1MHz, 1±0.2Vrms Y5P: tanδ=2.5% Max. @20°C, 1KHz, 1±0.2Vrms Y5U: tanδ=2.5% Max. @20°C, 1KHz, 1±0.2Vrms Y5V: tanδ=5.0% Max. @20°C, 1KHz, 1±0.2Vrms
Insulation Resistance	10000MΩ at 500VDC for 60 Seconds
Dielectric Strength	1500VAC for 60 Seconds (AC TYPE) (For Lead Pitch=5.0mm)
	2600VAC for 60 Seconds (AC TYPE) (For Lead Pitch=7.5 & 10 mm)
	4000VAC for 60 Seconds (AH,AS TYPE) (For Lead Pitch=10.0mm& 12.5mm)

Typical characteristic curves & Z(Impedance) vs. frequency :

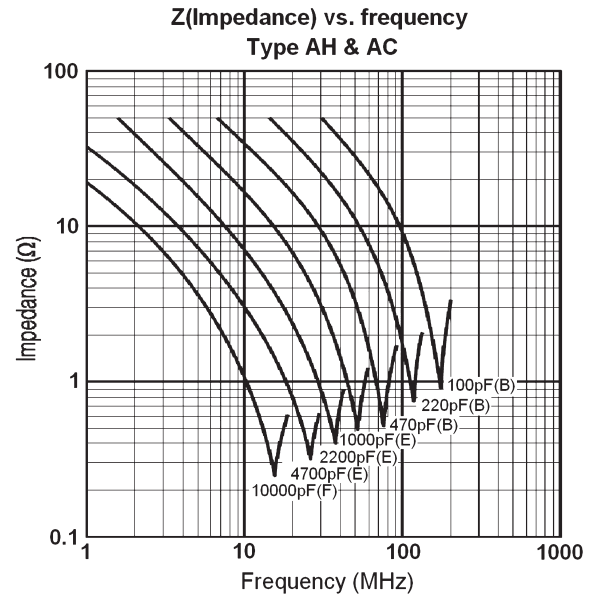
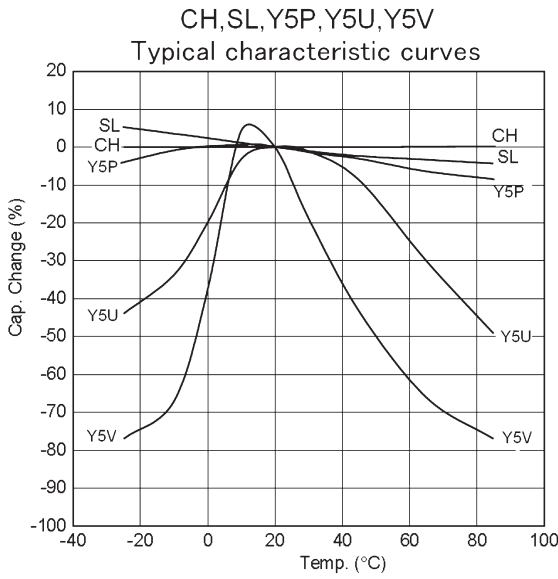

Note: Above data are just for reference not assured ones.

Leakage Current Characteristics (AH and AS: ~4000V / AC: ~2600V):

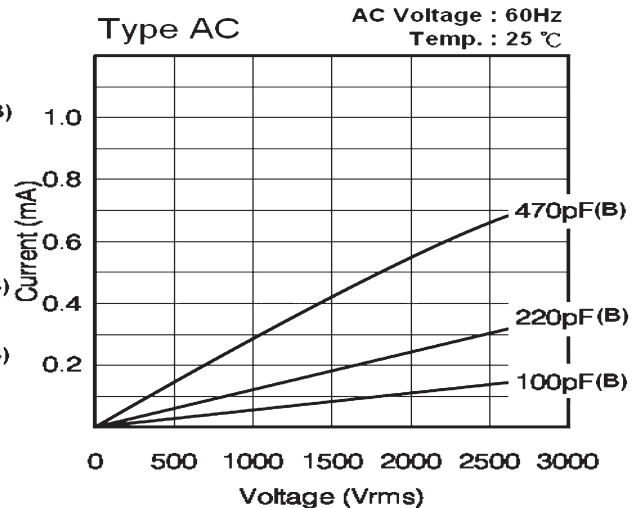
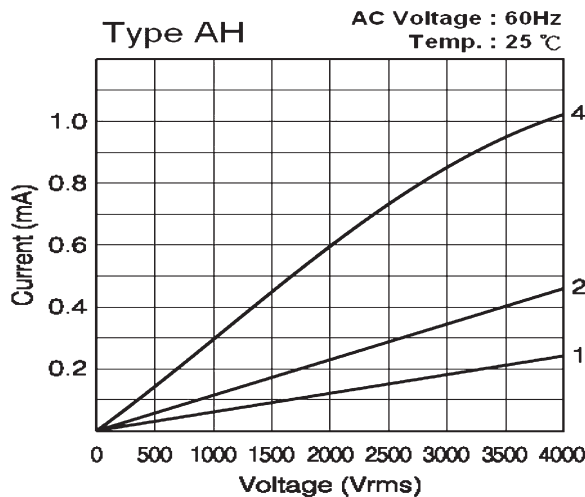
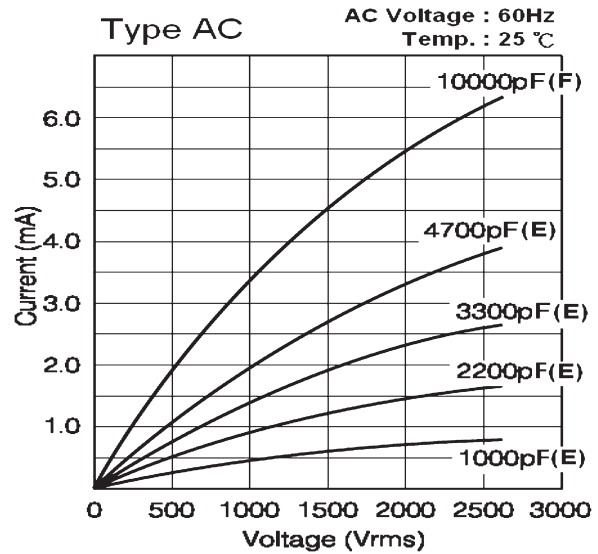
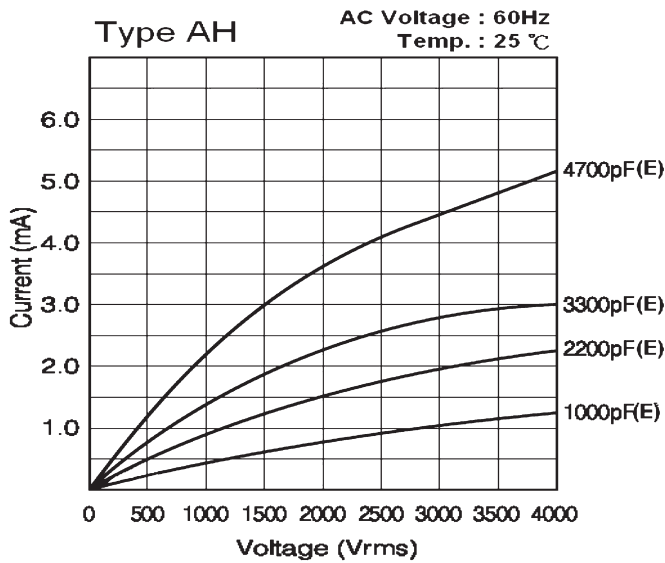

Note: Above data are just for reference not assured ones.

AH Type-Class X1/Y1(Normal for standard parts)

Part Number	Temp. Char.	Cap.(pF)	Tol.	Dimension (mm)			
				D Max.	T Max.	F±1	Wire Dia. (Ød)
YP *AH101K060	Y5P	100	±10%	7.0	5.0	10.0	0.55±0.05
YP *AH151K060		150		7.0			
YP *AH221K060		220		7.0			
YP *AH331K060		330		7.0			
YP *AH471K070		470		8.0			
YP *AH561K080		560		9.0			
YP *AH681K080		680		9.0			
YP *AH102K100		1000		11.0			
YU *AH102M070		Y5U		1000			
YU *AH152M080	1500		9.0				
YU *AH222M090	2200		10.0				
YU *AH332M110	3300		12.0				
YU *AH392M120	3900		14.0				
YU *AH472M130	4700		14.0				
YV *AH102M060	Y5V	1000	±20%	7.0	5.5	10.0	0.55±0.05
YV *AH152M070		1500		8.0			
YV *AH222M080		2200		9.0			
YV *AH332M100		3300		11.0			
YV *AH472M110		4700		12.0			
CH *AH***C060	CH (NPO)	2,3,4,5	±0.25pF	7.0	5.0	10.0	0.55±0.05
CH *AH***D060		6,7,8,9,10	±0.5pF	7.0			
CH *AH120J060		12	±5%	7.0			
CH *AH ***J070		15,18,20,22,24,27		8.0			
SL *AH ***J060	SL	15,18,20,22,24, 27,30,33,36,39	±5%	7.0	5.0	10.0	0.55±0.05
SL *AH ***J070		47,50,51,56,62		8.0			
SL *AH ***J080		68,75		9.0			
SL *AH101J090		82,100		10.0			

AS Type-Class X1/Y1 (Normal for standard parts)

SAP P/N	T.C.	Capacitance(pF)	Tolerance	Dimension (unit:mm)			
				D(max.)	T(max.)	F	Φd
YP*AS101K070*	Y5P	100 pF	±10%	8.0	7.0	10.0	0.55+/-0.05
YP*AS151K070*		150 pF		8.0			
YP*AS221K070*		220 pF		8.0			
YP*AS331K070*		330 pF		8.0			
YP*AS471K080*		470 pF		9.0			
YP*AS561K090*		560 pF		10.0			
YP*AS681K090*		680 pF		10.0			
YP*AS102K110*		1000 pF		12.0			
YU*AS102M080*		Y5U		1000 pF			
YU*AS152M090*	1500 pF		10.0				
YU*AS222M120*	2200 pF		13.0				
YU*AS332M120*	3300 pF		13.0				
YU*AS392M130*	3900 pF		14.0				
YU*AS472M140*	4700 pF		15.0				

SAFETY STANDARD CERAMIC CAPACITOR

Detail Specification

AC Type-Class X1/Y2

Part Number	Temp. Char.	Cap.(pF)	Tol.	Dimension (mm)			
				D max.	T max.	F±1	Wire Dia. (Ød)
YP *AC101K060	Y5P	100	±10%	7.0	5.0	7.5, 10.0	0.55±0.05
YP *AC151K060		150		7.0			
YP *AC221K060		220		7.0			
YP *AC331K060		330		7.0			
YP *AC471K060		470		7.0			
YP *AC561K070		560		8.0			
YP *AC681K070		680		8.0			
YP *AC821K080		820		9.0			
YP *AC102K080		1000		9.0			
YU *AC102M060		Y5U		1000			
YU *AC152M080	1500		9.0				
YU *AC222M080	2200		9.0				
YU *AC332M100	3300		11.0				
YU *AC392M120	3900		13.0				
YU *AC472M120	4700		13.0				
YV *AC102M060	Y5V	1000	±20%	7.0	5.0	7.5, 10.0	0.55±0.05
YV *AC152M060		1500		7.0			
YV *AC222M060		2200		7.0			
YV *AC332M080		3300		9.0			
YV *AC392M100		3900		11.0			
YV *AC472M100		4700		11.0			
YV *AC682M120		6800		13.0			
YV *AC103M140		10000		15.0			
CH *AC *** C060	CH (NPO)	2,3,4,5	±0.25pF	7.0	5.0	7.5, 10.0	0.55±0.05
CH *AC *** D060		6,7,8,9,10	±0.5pF	7.0			
CH *AC *** J060		12,15	±5%	7.0			
CH *AC *** J070		18,20,22,24		8.0			
CH *AC *** J080		27,30,33		9.0			
CH *AC *** J090		36,39		10.0			
CH *AC470J100		47		11.0			
SL *AC *** J060	SL	10,12,15,18,20,22 ,24,27,30,33,36, 39,47,50,51	±5%	7.0	5.0	7.5, 10.0	0.55±0.05
SL *AC *** J070		56,62,68,75		8.0			
SL *AC820J080		82		9.0			
SL *AC101J090		100		10.0			

 = **Lead Code** : Please consult our part number explanation on page 20 for detail lead space, lead length, and lead configuration.

■ Taping Format: AH and AS X1/Y1

- 25.4mm pitch/lead spacing 10.0mm taping
- Lead Code: *BAMD0 & *DAMD0 & *XAMD0

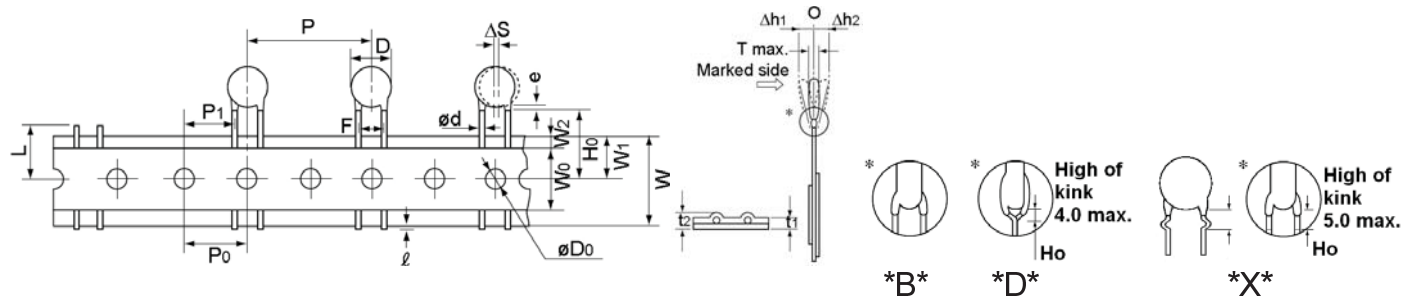

POE Part Number	*BAMD0 / *DAMD0 / *XAMD0	
Item	Symbol	Dimensions(mm)
Pitch of component	P	25.4 ± 2
Pitch of sprocket	P0	12.7 ± 0.3
Lead spacing	F	10.0 ± 1.0
Length from hole center to component center	P2	12.7 ± 1.5
Length from hole center to lead	P1	7.7 ± 1.5
Body diameter	D	Refer to page 23
Deviation along tape, left or right	ΔS	0 ± 2.0
Carrier tape width	W	18.0 +1/-0.5
Position of sprocket hole	W1	9.0 ± 0.5
Lead distance between the kink and center of sprocket hole	H0	18.0 +2.0/-0 (For: *DAMD0 & *XAMD0)
Lead distance between the bottom of body and the center of sprocket hole	H	20.0+1.5/-1.0 (For: *BAMD0)
Protrusion length	ℓ	2.0max (Or the end of lead wire may be inside the tape.)
Diameter of sprocket hole	D0	4.0 ± 0.2
Lead diameter	φd	0.55±0.05
Total tape thickness	t1	0.6 ± 0.3
Total thickness, tape and lead wire	t2	1.5 max.
Deviation across tape	Δh1	2.0 max.
	Δh2	2.0 max
Portion to cut in case of defect	L	11.0 max.
Hole-down tape width	W0	8.0 min
Hole-down tape distortion	W2	1.5 ± 1.5
Coating extension on leads	e	3.0 max for straight lead style; Not exceed the kink leads for kink lead.
Body thickness	T	Refer to page 23

SAFETY STANDARD CERAMIC CAPACITOR

Taping Specification and Dimension

■ Taping Format: AC X1/Y2

• 15mm pitch/lead spacing 7.5mm taping
Lead Code: *BAFD7 & *DAFD7 & *XAFD7

• 25.4mm pitch/lead spacing 7.5mm taping
Lead Code: *BAMD7 & *DAMD7 & *XAMD7

• 25.4mm pitch/lead spacing 10.0mm taping
Lead Code: *BAMD0 & *DAMD0 & *XAMD0

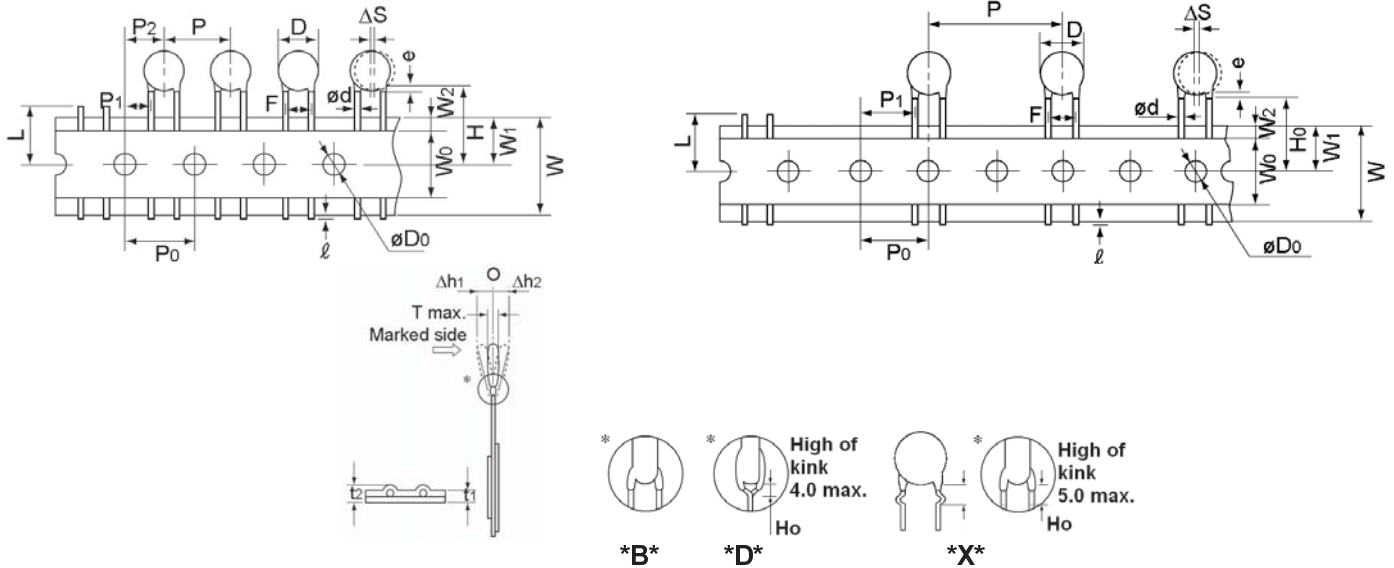

POE Part Number		*BAFD7	*DAFD7 *XAFD7	*BAMD7 *DAMD7 *XAMD7	*BAMD0 *DAMD0 *XAMD0
Item	Symbol	Dimensions (mm)			
Pitch of component	P	15.0	15.0	25.4	25.4
Pitch of sprocket	P0	15.0±0.3	15.0±0.3	12.7±0.3	12.7±0.3
Lead spacing	F	7.5±1.0	7.5±1.0	7.5±1.0	10.0±1.0
Length from hole center to component center	P2	7.5±1.5	7.5±1.5	12.7±1.5	12.7 ± 1.5
Length from hole center to lead	P1	3.75±1.0	3.75±1.0	8.95±1.0	7.7±1.5
Body diameter	D	Refer to page 24			
Deviation along tape, life or right	ΔS	0±2.0			
Carrier tape width	W	18.0 +1/-0.5			
Position of sprocket hole	W1	9.0±0.5			
Lead distance between the kink and center of sprocket hole	H0	---	18.0+2.0/-0	18.0+2.0/-0 (For: *DAMD7 / *XAMD7)	18.0+2.0/-0 (For: *DAMD0 / *XAMD0)
Lead distance between the bottom of body and the center of sprocket hole	H	20.0+1.5/-1.0	---	20.0+1.5/-1.0 (For: *BAMD7)	20.0+1.5/-1.0 (For: *BAMD0)
Protrusion length	ℓ	2.0max (Or the end of lead wire may be inside the tape.)			
Diameter of sprocket hole	D0	4.0±0.2			
Lead diameter	φd	0.55±0.05			
Total tape thickness	t1	0.6±0.3			
Total thickness, tape and lead wire	t2	1.5 max.			
Deviation across tape	Δh1/Δh2	2.0 max.			
Portion to cut in case of defect	L	11.0 max.			
Hole-down tape width	W0	8.0 min			
Hole-down tape distortion	W2	1.5±1.5			
Coating extension on leads	e	3.0 max for straight lead style; Not exceed the kink leads for kink lead.			
Body thickness	T	Refer to page 24			

■ Marking : AH

1.Type Designation	AH		
2.Nominal Capacitance	3-digit-system		
3.Capacitance Tolerance	C:±0.25pF,D:±0.5pF,J:±5%,K:±10%,M:±20%		
4.Company Trade mark	UK		
5.Products ID	Abbreviation ex.: <div style="display: flex; justify-content: space-around; align-items: center;"> <div style="text-align: center;"> <p>Last digits of year: ← 3 C 5 1234 →</p> <p>3:2013 4:2014 5:2015 ⋮</p> <p>↓</p> <p>Manufacture: C: Guangzhou (Pan overseas)</p> </div> <div style="text-align: center;"> <p>↓</p> <p>Epoxy resin code: " _ ": Halogen and Pb free, epoxy resin.</p> </div> <div style="text-align: center;"> <p>→</p> <p>Last 4 digits of Lot no.</p> <p>Month of manufacture 1: January ⋮ 9: setemper O: October N: November D: December</p> </div> </div>		
6.Approved Monogram:			
(1) VDE approval mark		IEC 60384-14 3rd (2005). Class Code:X1:400V~,Y1:250V~ or400V~	
(2) UL approval mark		(6) DEMKO approval mark	
(3) CSA approval mark		(7) FIMKO approval mark	
(4) SEMKO approval mark		(8) SEV approval mark	
(5) NEMKO approval mark		(9) CQC approval mark	
Two sides (For SAP part number 10-11 digits≤07 products)	One side (For SAP part number 10-11 digits≥“08” products)		
Ex.:	Ex.:		Special marking: YP*AH102K100*
0AH : 1AH :	0AH: 1AH:		OAH: 1AH:
* Marking by the laser. **"C" : Marked with code " _ " stand for Halogen and Pb free for epoxy resin coating.			





SAFETY STANDARD CERAMIC CAPACITOR

Taping Specification and Dimension

■ Marking : AC

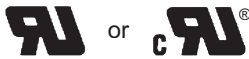
1.Type Designation	AC								
2.Nominal Capacitance	3-digit-system								
3.Capacitance Tolerance	C:±0.25pF,D:±0.5pF,J:±5%,K:±10%,M:±20%								
4.Company Trade mark	UK								
5.Products ID	<p>Abbreviation ex.</p> <div style="display: flex; justify-content: space-between; align-items: center;"> <div style="text-align: center;"> <p>Last digits of year: ← 3 C 5 1234</p> <p>3:2013 4:2014 5:2015 ⋮</p> <p>Manufactory: C: Guangzhou (Pan overseas)</p> </div> <div style="text-align: center;"> <p>→ Last 4 digits of Lot no.</p> <p>Epoxy resin code: " _ ": Halogen and Pb free, epoxy resin.</p> </div> <div style="text-align: center;"> <p>→ Month of manufacture</p> <p>1:January ⋮ 9:setemper O:October N:November D:December</p> </div> </div>								
6.Approved monogram:									
6.1 VDE		6.3 CSA		6.5 NEMKO		6.7 FIMKO		6.9 CQC	
6.2 UL		6.4 SEMKO		6.6 DEMKO		6.8 SEV			
Marking Ex.:	Type	Two sides marking (For SAP part number 10-11 digits≤07 products)				One side marking (For SAP part number 10- 11 digits≥“08” products)			
	<u>0AC</u> X1:400Vac Y2:250Vac								
	Type	Two sides marking (For SAP part number 10-11 digits≤07 products)				One side marking (For SAP part number 10- 11 digits≥“08” products)			
	<u>1AC</u> X1:440Vac Y2:300Vac								
<p>* Marking by the laser.</p> <p>* "C" : Marked with code " _ " stand for Halogen and Pb free for epoxy resin coating.</p>									

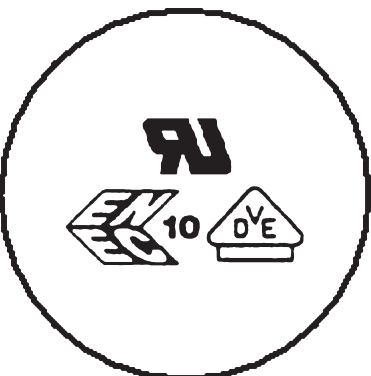
■ Marking : AS

1.Type Designation	AS	
2.Nominal Capacitance	3-digit-system	
3.Capacitance Tolerance	K:±10%,M:±20%	
4.Company Name Code(Trade mark)	UK	
5. Products ID	Abbreviation ex.: Manufacture year: ← 3 C 6 1234 → Last 4 digits of lot no. 3:2013 4:2014 5:2015 : Manufacture month: 1:January 2:February : 9:September 0:October N:November D:December Epoxy resin code: " _ ": Halogen and Pb free epoxy resin (For the last code "H" and "B" of SAP P/N) Manufacture: C:Pan overseas (Guangzhou)	
6.Approved Monogram:		
(1) VDE approval mark		IEC 60384-14 Class code:X1:760V~, Y1:500V~
(2) UL approval mark		
Marking sample		
Two sides marking (for SAP part number 10-11 digits ≤"08" products)		One side marking (for SAP part number 10-11 digits ≥"09" products)
 		
<p>* Marking by the laser. **"C":Marked with code " _ " stand for Halogen and Pb free epoxy resin.</p>		

RADIAL LEADED MULTILAYER CERAMIC CAPACITOR

SAP Part Number Explanation

To order, please also specify Pan Overseas Part No. as the following example for SAP system :

RD21	B	102	K	500	B	5	C	07	B
①	②	③	④	⑤	⑥	⑦	⑧	⑨	⑩

① Product Type

Product Type	
RD21	RD20

② Dielectric Code

Code	T.C.	OP Temperature	Cap. Change ($\Delta^{\circ}\text{C}$)
N	NPO	-55~+125 $^{\circ}\text{C}$	0 \pm 30 (ppm/ $^{\circ}\text{C}$)
B	X7R	-55~+125 $^{\circ}\text{C}$	\pm 15%
F	Y5V	-25~+85 $^{\circ}\text{C}$	+30% ~ -80%

③ Capacitance Code

Code	Capacitance	Code	Capacitance	Code	Capacitance	Code	Capacitance
010	1 pF	100	10 pF	102	1000 pF	103	10000 pF
1R5	1.5 pF	101	100 pF	472	4700 pF	104	100000 pF

Tolerance Code

Code	Tolerance	Code	Tolerance	Code	Tolerance	Code	Tolerance
J	\pm 5%	K	\pm 10%	M	\pm 20%	Z	+80% / -20%

⑤ Rated Voltage

Code	Voltage	Code	Voltage	Code	Voltage	Code	Voltage	Code	Voltage
100	10V	250	25V	101	100V	251	250V	631	630V
160	16V	500	50V	201	200V	501	500V	102	1000V

⑥ Packaging Code

Code	Packing
A	Ammo
B	Bulk

⑦ Chip Size

Code	Chip Size
5	0805
6	1206

⑧ Termination

Code	Termination	Code	Termination	Code	Termination	Code	Termination
A	Ag/Ni/Sn Halogen free	L	Ag/Ni/Sn	H	Cu/Ni/Sn Halogen free	C	Cu/Ni/Sn

⑨ -1 Lead Length for Bulk

Code	Length
07	7.0 mm
3E	3.5 mm
05	5.0 mm

⑨ -2 Packing for Taping

Code	Packing
AN	Ammo

⑩ Length Tolerance

Code	Length Tol.	Code	Length Tol.
A	\pm 0.5 mm	D	Taping.
B	\pm 1.0 mm		

Features:

1. MLC Radial Lead Capacitor (RD) has wide application in computer, data processing, telecommunication, industrial control and instrumentation equipment
2. The radial lead MLC is built with superior moisture, and shock resistant epoxy coating material, can be supplied in both, bulk or taping form for automatic insertion
3. RoHS compliance
4. Halogen free products are available

Lead configuration and dimension:

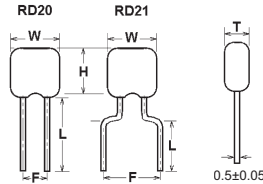

(Unit: mm)

Size	Width (W) Max.	Height (H) Max.	Thickness (T) Max.	Length (L)	Lead spacing for Taping (F)	Lead spacing for Bulk (F)	Lead diameter (d)
RD20	0805	5.5	5.5	4.0	Refer to the item ⊙-1 SAP Part Number	2.5±1.0	0.5±0.05
	1206	6.5	5.5	4.0		2.54±1.0	
RD21	0805	5.5	5.5	4.0		5.0±1.0	
	1206	6.5	5.5	4.0		5.08±1.0	

Taping Specification:

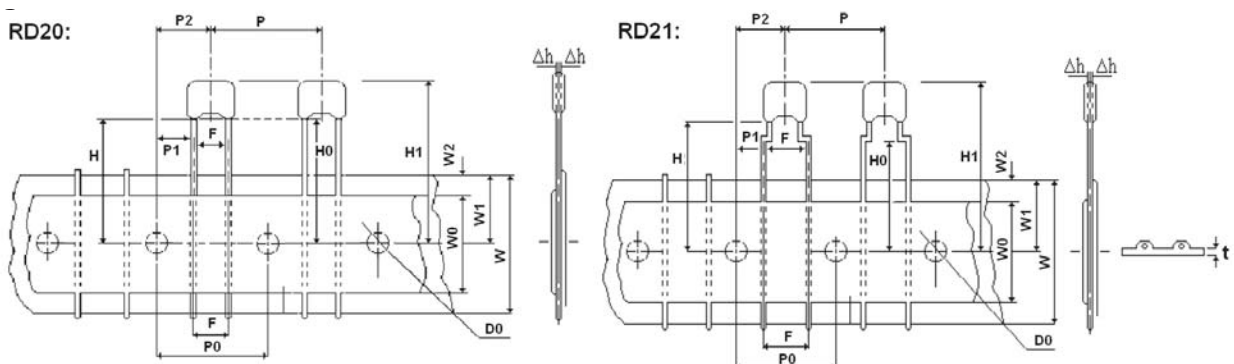

ITEM	SYMBOL	DIMENSIONS (mm)	REMARKS
Pitch of Components	P	12.7 ± 1.0	
Feed hole pitch	P0	12.7 ± 0.3	Cumulative pitch error : ± 1.0mm / 20 pitches
Feed hole center to lead	P1	5.1 ± 0.7 (for RD20) 3.85 ± 0.7 (for RD21)	
Feed hole center to component center	P2	6.35 ± 1.3	
Lead diameter	d	0.5±0.05	
Lead to lead spacing	F	2.5 ± 0.8 (for RD20) 5.0 ± 0.8 (for RD21)	To lead top within tolerance
Component alignment, F - R	Δh	2.0 max	The alignment from the center of the lead is ± 1.0mm
Tape width	W	18.0 -1.0 / -0.5	
Adhesive tape width	W0	8.0 min	
Hole position	W1	9.0 ± 0.5	
Adhesive tape position	W2	3.0 max	
Height of bottom body from tape center	H	18.0 + 2.0 / -0	H + 12.5 mm ≤ H1
Lead-wire clinch height	H0	18.0 ± 0.5 (for RD20) 16.0 ± 0.5 (for RD21)	6.5 ≤ H0 - W1
Component height	H1	32.25 max	
Feed hoe diameter	D0	4.0 ± 0.3	
Total tape thickness	T	0.7 ± 0.2	

RADIAL LEADED MULTILAYER CERAMIC CAPACITOR

Capacitance Range

Capacitance Range

Dielectric		NPO										
Size		0805					1206					
Voltage (VDC)		50	100	200	250	50	100	200	250	500	630	1000
Capacitance	1.0pF (010)	B	B	B	B							
	1.2pF (1R2)	B	B	B	B							
	1.5pF (1R5)	B	B	B	B	B	B	B	B	B	B	B
	1.8pF (1R8)	B	B	B	B	B	B	B	B	B	B	B
	2.2pF (2R2)	B	B	B	B	B	B	B	B	B	B	B
	2.7pF (2R7)	B	B	B	B	B	B	B	B	B	B	B
	3.3pF (3R3)	B	B	B	B	B	B	B	B	B	B	B
	3.9pF (3R9)	B	B	B	B	B	B	B	B	B	B	B
	4.7pF (4R7)	B	B	B	B	B	B	B	B	B	B	B
	5.6pF (5R6)	B	B	B	B	B	B	B	B	B	B	B
	6.8pF (6R8)	B	B	B	B	B	B	B	B	B	B	B
	8.2pF (8R2)	B	B	B	B	B	B	B	B	B	B	B
	10pF (100)	B	B	B	B	B	B	B	B	B	B	B
	12pF (120)	B	B	B	B	B	B	B	B	B	B	B
	15pF (150)	B	B	B	B	B	B	B	B	B	B	B
	18pF (180)	B	B	B	B	B	B	B	B	B	B	B
	22pF (220)	B	B	B	B	B	B	B	B	B	B	B
	27pF (270)	B	B	B	B	B	B	B	B	B	B	B
	33pF (330)	B	B	B	B	B	B	B	B	B	B	B
	39pF (390)	B	B	B	B	B	B	B	B	B	B	B
	47pF (470)	B	B	B	B	B	B	B	B	B	B	B
	56pF (560)	B	B	B	B	B	B	B	B	B	B	B
	68pF (680)	B	B	B	B	B	B	B	B	B	B	B
	82pF (820)	B	B	B	B	B	B	B	B	B	B	B
	100pF (101)	B	B	B	B	B	B	B	B	B	B	B
	120pF (121)	B	B	B	B	B	B	B	B	B	B	B
	150pF (151)	B	B	B	B	B	B	B	B	B	B	B
	180pF (181)	B	B	B	B	B	B	B	B	B	B	B
	220pF (221)	B	B	B	B	B	B	B	B	B	B	B
	270pF (271)	B	B	B	B	B	B	B	B	B	B	B
	330pF (331)	B	B	B	B	B	B	B	B	B	B	B
	390pF (391)	B	B	B	B	B	B	B	B	B	B	B
	470pF (471)	B	B	B	B	B	B	B	B	B	B	B
	560pF (561)	B	B	B	B	B	B	B	B	B	B	B
680pF (681)	B	B	B	B	B	B	B	B	B	B	B	
820pF (821)	B	B	B	B	B	B	B	B	B	B	B	
1000pF (102)	B	B	B		B	B	B	B	B	B	B	
1200pF (122)	B	B			B	B	B	B	B	B	B	
1500pF (152)	B	B			B	B	B	B	B	B	B	
1800pF (182)	B	B			B	B	B	B	B	B	B	
2200pF (222)	B	B			B	B	B	B	B	B	B	
2700pF (272)	B	B			B	B						
3300pF (332)	B	B			B	B						
3900pF (392)	B	B			B	B						
4700pF (472)	B	B			B	B						
5600pF (562)	B				B	B						
6800pF (682)	B				B	B						
8200pF (822)	B				B	B						
0.01uF (103)	B				B							

Dielectric		X7R										
Size		0805					1206					
Voltage (VDC)		50	100	200	250	50	100	200	250	500	630	1000
Capacitance	100pF (101)	B	B	B	B							
	120pF (121)	B	B	B	B							
	150pF (151)	B	B	B	B	B	B	B	B	B	B	B
	180pF (181)	B	B	B	B	B	B	B	B	B	B	B
	220pF (221)	B	B	B	B	B	B	B	B	B	B	B
	270pF (271)	B	B	B	B	B	B	B	B	B	B	B
	330pF (331)	B	B	B	B	B	B	B	B	B	B	B
	390pF (391)	B	B	B	B	B	B	B	B	B	B	B
	470pF (471)	B	B	B	B	B	B	B	B	B	B	B
	560pF (561)	B	B	B	B	B	B	B	B	B	B	B
	680pF (681)	B	B	B	B	B	B	B	B	B	B	B
	820pF (821)	B	B	B	B	B	B	B	B	B	B	B
	1000pF (102)	B	B	B	B	B	B	B	B	B	B	B
	1200pF (122)	B	B	B	B	B	B	B	B	B	B	B
	1500pF (152)	B	B	B	B	B	B	B	B	B	B	B
	1800pF (182)	B	B	B	B	B	B	B	B	B	B	B
	2200pF (222)	B	B	B	B	B	B	B	B	B	B	B
	2700pF (272)	B	B	B	B	B	B	B	B	B	B	B
	3300pF (332)	B	B	B	B	B	B	B	B	B	B	B
	3900pF (392)	B	B	B	B	B	B	B	B	B	B	B
	4700pF (472)	B	B	B	B	B	B	B	B	B	B	B
	5600pF (562)	B	B	B	B	B	B	B	B	B	B	B
	6800pF (682)	B	B	B	B	B	B	B	B	B	B	B
	8200pF (822)	B	B	B	B	B	B	B	B	B	B	B
	0.01uF (103)	B	B	B	B	B	B	B	B	B	B	B
	0.012uF (123)	B	B	B	B	B	B	B	B	B	B	B
	0.015uF (153)	B	B	B	B	B	B	B	B	B	B	B
	0.018uF (183)	B	B	B	B	B	B	B	B	B	B	B
	0.022uF (223)	B	B	B	B	B	B	B	B	B	B	B
	0.027uF (273)	B	B			B	B	B	B	B	B	B
	0.033uF (333)	B	B			B	B	B	B	B	B	B
	0.039uF (393)	B	B			B	B	B	B	B	B	B
	0.047uF (473)	B	B			B	B	B	B	B	B	B
	0.056uF (563)	B	B			B	B	B	B	B	B	B
0.068uF (683)	B	B			B	B	B	B	B	B	B	
0.082uF (823)	B	B			B	B	B	B	B	B	B	
0.1uF (104)	B	B			B	B	B	B	B	B	B	
0.12uF (124)	B				B	B						
0.15uF (154)	B				B	B						
0.18uF (184)	B				B	B						
0.22uF (224)	B				B	B						
0.27uF (274)	B				B							
0.33uF (334)	B				B							
0.39uF (394)	B				B							
0.47uF (474)	B				B							
0.56uF (564)	B				B							
0.68uF (684)	B				B							
0.82uF (824)	B				B							
1.0uF (105)	B				B							

Dielectric		Y5V													
Size		0805							1206						
Voltage (VDC)		10	16	25	50	100	200	250	10	16	25	50	100	200	250
Capacitance	0.01uF (103)	B	B	B	B	B	B	B	B	B	B	B	B	B	B
	0.015uF (153)	B	B	B	B	B	B	B	B	B	B	B	B	B	B
	0.022uF (223)	B	B	B	B	B	B	B	B	B	B	B	B	B	B
	0.033uF (333)	B	B	B	B	B	B	B	B	B	B	B	B	B	B
	0.047uF (473)	B	B	B	B	B	B	B	B	B	B	B	B	B	B
	0.068uF (683)	B	B	B	B	B	B	B	B	B	B	B	B	B	B
	0.1uF (104)	B	B	B	B	B	B	B	B	B	B	B	B	B	B
	0.15uF (154)	B	B	B	B	B	B	B	B	B	B	B	B	B	B
	0.22uF (224)	B	B	B	B	B	B	B	B	B	B	B	B	B	B
	0.33uF (334)	B	B	B	B	B	B	B	B	B	B	B	B	B	B
	0.47uF (474)	B	B	B	B	B	B	B	B	B	B	B	B	B	B
	0.68uF (684)	B	B	B	B	B	B	B	B	B	B	B	B	B	B
	1.0uF (105)	B	B	B	B	B	B	B	B	B	B	B	B	B	B
	1.5uF (155)	B	B												
	2.2uF (225)	B	B	B											
	3.3uF (335)	B	B												
4.7uF (475)	B	B	B												
6.8uF (685)	B														
10uF (106)	B														
22uF (226)	B														

•The letter in cell is expressed the symbol of product terminations. B: (Cu/Ni/Sn)

Y Cap.(AH and AC series)	Packing type	The code of 14th to15th in SAP P/N		MPQ (Kpcs/Box)		Remark
	Taping	AF		1		
		AT		0.5		
		AM		0.5		For size code ≤ 11
		AM		1		For size code ≥ 12
		AN		1		
	Packing type	Lead length	Size code of 10th to 11th in SAP P/N	MPQ (Kpcs/Bag)	Kpcs/Box	Remark
	Bulk	Long lead ($L \geq 20\text{mm}$)	06~12	0.5	1.5	
			13-15	0.5	1	
		Short lead ($L < 20\text{mm}$)	06~14	0.5	2	
15			0.2	1		
All			16	0.2	1	

Disc DC Cap. (50V~6KVdc)	Packing type	The code of 14th to15th in SAP P/N		MPQ (Kpcs/Box)		Remark
	Taping	AF		1		
		AT		0.5		
		AM		0.5		
		TN		2		
		AN		2		Phenolic resin
		AN		1.5		Epoxy resin
	Packing type	Lead length	Size code of 10th to 12th in SAP P/N	MPQ (Kpcs/Bag)	Kpcs/Box	Remark
	Bulk	Long lead ($L \geq 20\text{mm}$)	040~070	1	3	Phenolic resin
			080~100	1	2	Phenolic resin
			050~100	1	2	Epoxy resin
			110~120	0.5	1.5	
			130~170	0.5	1	
		Short lead ($L < 20\text{mm}$)	040~060	1	6	
			070~080	1	4	
090~100			1	3		
110~140			1	2		
150~170			0.5	1		

RD Cap. (Multilayer Radial Leded Type)	Packing type	The code of 16th to17th in SAP P/N		MPQ (Kpcs/Box)		Remark
	Taping	TN		2		
		AN		2		Size of chip ≤ 0805
		AN		1.5		Size of chip > 0805
	Packing type	Lead length		MPQ (Kpcs/Bag)	Kpcs/Box	Remark
	Bulk	Long lead ($L \geq 20\text{mm}$)		1	4	
Short lead ($L < 20\text{mm}$)		1	20			

Ruled area for writing with horizontal dashed lines.